

Product description **Bayonet male cable connector, Contacts: 8, 4.0 - 5.0 mm, unshielded, solder, IP40**

Area **Bayonet series 710**
Order number **99 9479 102 08**

Illustration



Scale drawing

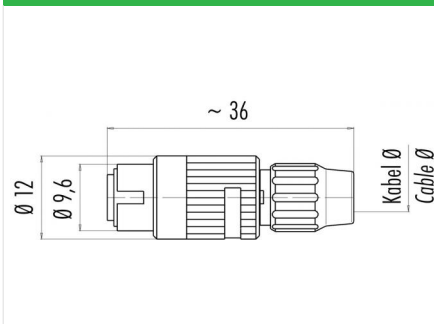

Contact arrangement (Plug-in side)

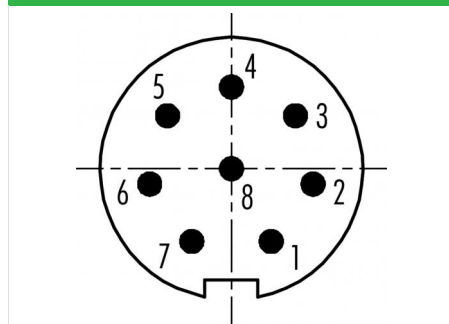

Technical data

General values

Connector design	male cable connector
Connector locking system	Bayonet
Termination	solder
Wire gauge (mm)	max. 0.14 mm ²
Wire gauge (AWG)	max. AWG 26
Cable outlet	4.0 - 5.0 mm
Upper limit temperature	85 °C
Lower limit temperature	-40 °C
Customs tariff number	85369010

Electrical values

Rated current (40 °C)	1 A
Rated voltage	125 V
Rated impulse voltage	1500 V
Pollution degree	1
Overvoltage category	II
Insulating material group	III
Insulation resistance	≥ 10 ¹⁰ Ω
EMC compliance	unshielded
Degree of protection	IP40
Mechanical operation	> 500 Mating cycles

Material

Contact material	CuZn (brass)
Contact plating	Au (gold)
Contact body material	PA (UL94 V-0)
Housing material	PA
REACH SVHC	CAS 7439-92-1 (Lead)

Product description	Bayonet male cable connector, Contacts: 8, 4.0 - 5.0 mm, unshielded, solder, IP40
Area	Bayonet series 710
Order number	99 9479 102 08

Security notices

The connector must not be plugged or unplugged under load. Non-observance and improper use can result in personal injury.

The connectors have been developed for applications in plant engineering, control and electrical equipment construction. The user is responsible for checking whether the connectors can also be used in other areas of application.

Connectors which are used in circuits with voltages dangerous to the touch may only be installed and used by, or under the supervision of, persons with electrical engineering training, taking into account the applicable regulations and standards.