

Product description Snap-In IP67 male panel mount connector, Contacts: 8, unshielded, solder, IP67
Area Snap-In IP67 series 620
Order number 99 9227 050 08

Illustration

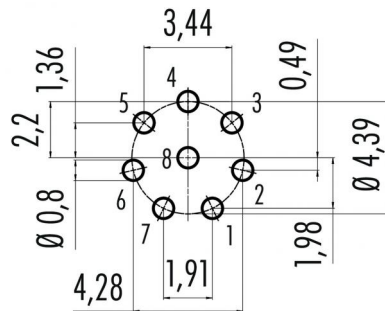

Conductor layout



Scale drawing

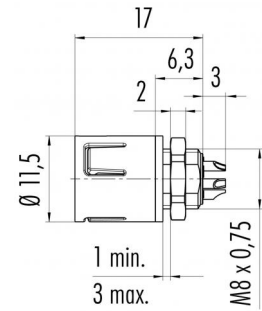

Contact arrangement (Plug-in side)

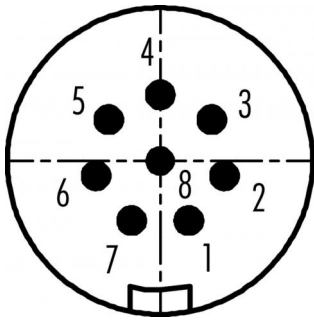

You can find the component part drawing and assembly instructions on the next page.

Technical data

General values

Connector design	male panel mount connector
Connector locking system	snap
Termination	solder
Wire gauge (mm)	max. 0.25 mm ²
Wire gauge (AWG)	max. AWG 24
Upper limit temperature	85 °C
Lower limit temperature	-25 °C
Customs tariff number	85369010

Electrical values

Rated current (40 °C)	1 A
Rated voltage	63 V
Rated impulse voltage	800 V
Pollution degree	2
Overvoltage category	II
Insulating material group	II
Insulation resistance	≥ 10 ¹⁰ Ω
EMC compliance	unshielded
Degree of protection	IP67
Mechanical operation	> 500 Mating cycles

Material

Contact material	CuZn (brass)
Contact plating	Au (gold)
Contact body material	PA (UL94 HB)
Housing material	PA
REACH SVHC	CAS 7439-92-1 (Lead)

Product description Snap-In IP67 male panel mount connector, Contacts: 8, unshielded, solder, IP67

Area Snap-In IP67 series 620
Order number 99 9227 050 08

Component part drawing

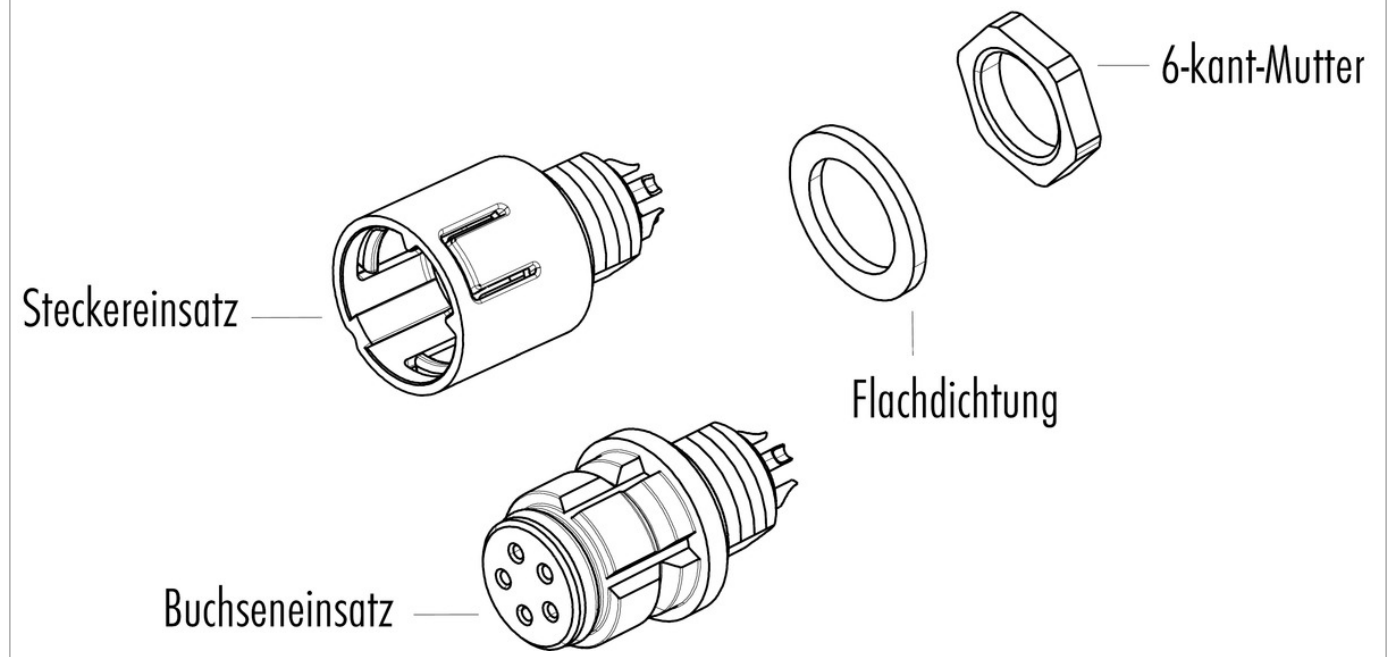

Assembly instructions / Panel cut-out

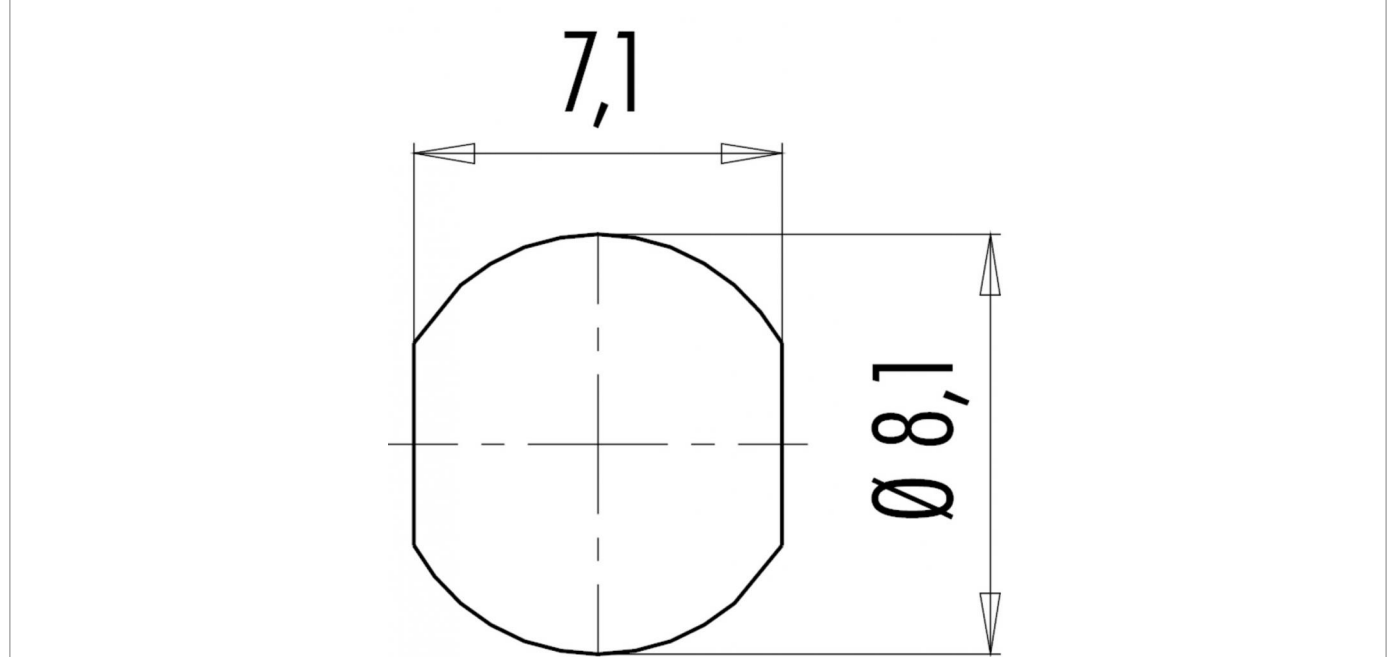

Product description **Snap-In IP67 male panel mount connector, Contacts: 8, unshielded, solder, IP67**

Area **Snap-In IP67 series 620**
Order number **99 9227 050 08**

Security notices

The connectors have been developed for applications in plant engineering, control and electrical equipment construction. The user is responsible for checking whether the connectors can also be used in other areas of application.

Plug connectors with enclosure protection IP 67 and IP 68 are not suitable for use under water. When used outdoors, the plug connectors must be protected separately against corrosion. For further information on the IP protection classes, please refer to the "Technical Information" download centre.