

Product description	Snap-In IP67 male cable connector, Contacts: 3, 4.0 - 6.0 mm, unshielded, solder, IP67, VDE
Area	Snap-In IP67 series 720
Order number	99 9105 60 03

Illustration	Scale drawing	Contact arrangement (Plug-in side)

You can find the component part drawing and assembly instructions on the next page.

Technical data

General values

Connector design	male cable connector
Connector locking system	snap
Termination	solder
Wire gauge (mm)	max. 0.75 mm ²
Wire gauge (AWG)	max. AWG 18
Cable outlet	4.0 - 6.0 mm
Upper limit temperature	85 °C
Lower limit temperature	-25 °C
Customs tariff number	85369010

Electrical values

Rated current (40 °C)	7 A
Rated voltage	250 V
Rated impulse voltage	2500 V
Pollution degree	2
Overvoltage category	II
Insulating material group	II
Insulation resistance	≥ 10 ¹⁰ Ω
EMC compliance	unshielded
Degree of protection	IP67
Mechanical operation	> 500 Mating cycles

Material

Contact material	CuZn (brass)
Contact plating	Au (gold)
Contact body material	PA (UL94 HB)
Housing material	PA
REACH SVHC	CAS 96-45-7 (Imidazolidine-2-thione) CAS 7439-92-1 (Lead)

authorization/approvals

Approval 1	VDE
------------	-----

Product description Snap-In IP67 male cable connector, Contacts: 3, 4.0 - 6.0 mm, unshielded, solder, IP67, VDE

Area Snap-In IP67 series 720
Order number 99 9105 60 03

Component part drawing

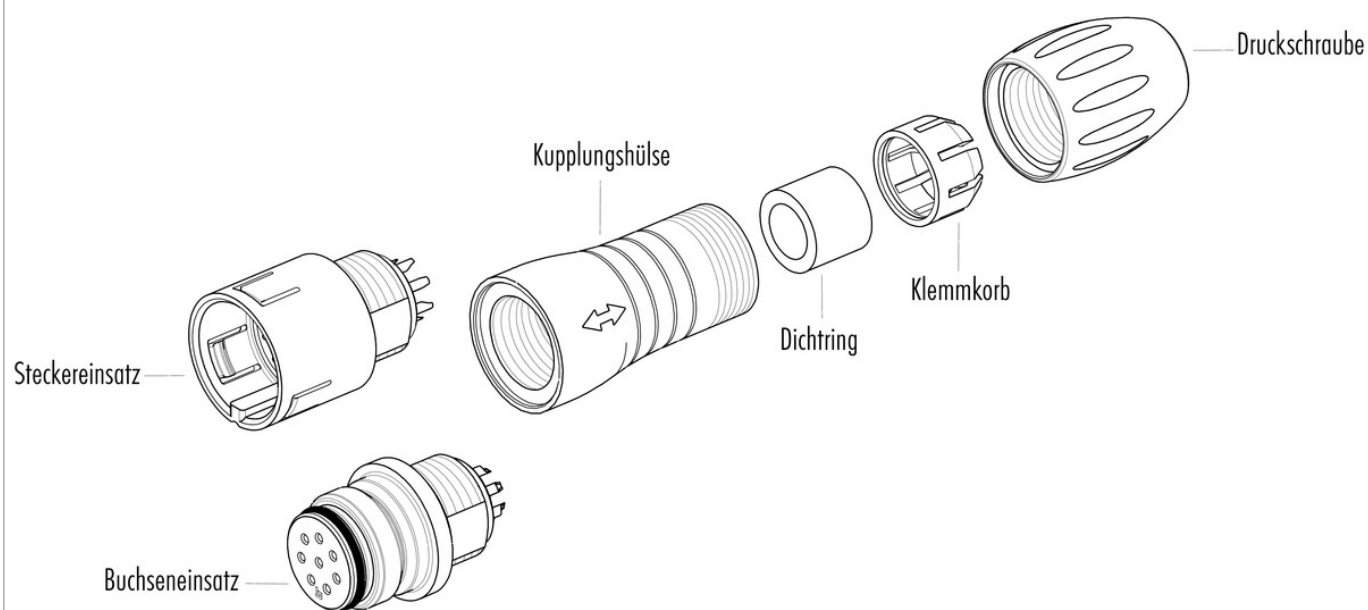

Assembly instructions / Panel cut-out

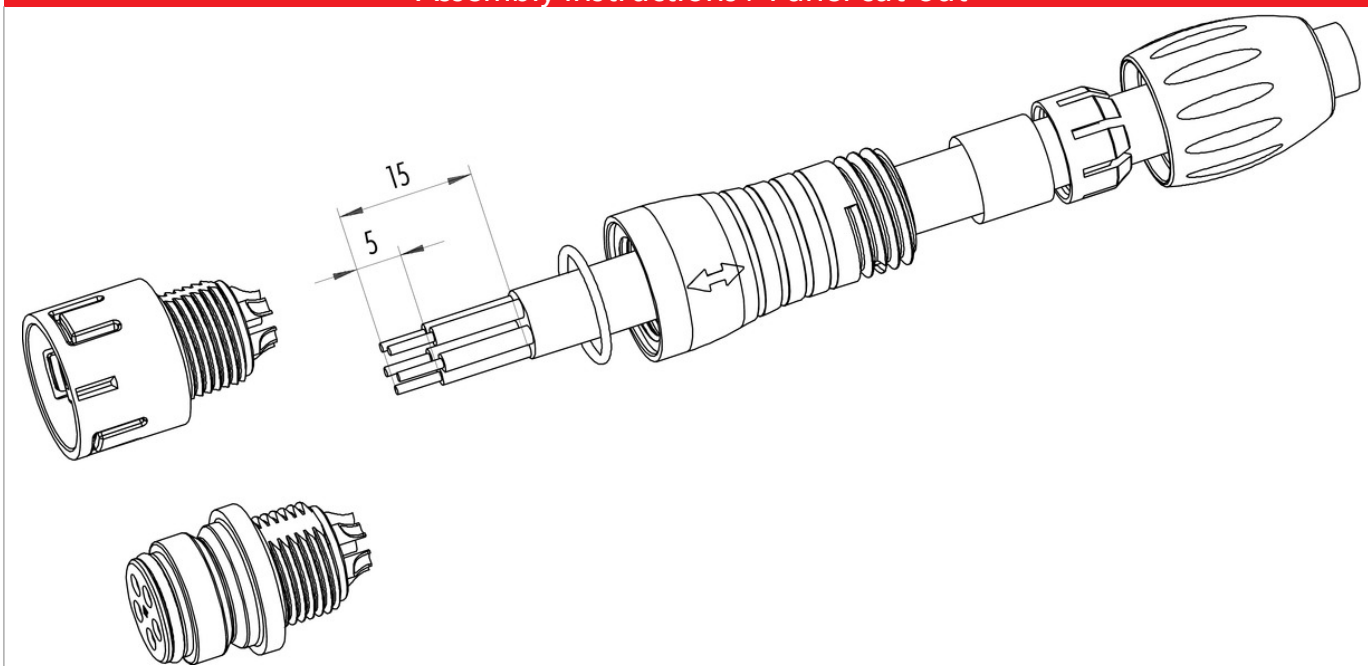

Product description	Snap-In IP67 male cable connector, Contacts: 3, 4.0 - 6.0 mm, unshielded, solder, IP67, VDE
Area	Snap-In IP67 series 720
Order number	99 9105 60 03

Security notices

The connector must not be plugged or unplugged under load. Non-observance and improper use can result in personal injury.

The connectors have been developed for applications in plant engineering, control and electrical equipment construction. The user is responsible for checking whether the connectors can also be used in other areas of application.

To protect against unintentional opening of the connector, the thread between the housing and the connector head must be secured with a suitable cyanoacrylate adhesive when used in circuits with voltages dangerous to the touch. This does not apply to connectors used in SELV and PELV circuits according to IEC 61140 (EN 61140, VDE 0140-1).

Connectors which are used in circuits with voltages dangerous to the touch may only be installed and used by, or under the supervision of, persons with electrical engineering training, taking into account the applicable regulations and standards.

Plug connectors with enclosure protection IP 67 and IP 68 are not suitable for use under water. When used outdoors, the plug connectors must be protected separately against corrosion. For further information on the IP protection classes, please refer to the "Technical Information" download centre.