

Product description	M16 IP67 female cable connector, Contacts: 5, 6.0 - 8.0 mm, shieldable, screw clamp, IP67, UL
Area	M16 IP67 series 423
Order number	99 5614 210 05

Illustration	Scale drawing	Contact arrangement (Plug-in side)

You can find the component part drawing on the next page.

Technical data

General values

Connector design	female cable connector
Connector locking system	screw
Termination	screw clamp
Wire gauge (mm)	0.25 - 1.5 mm ²
Wire gauge (AWG)	AWG 24 - 16
Cable outlet	6.0 - 8.0 mm
Upper limit temperature	95 °C
Lower limit temperature	-30 °C
Customs tariff number	85369010

Electrical values

Rated current (40 °C)	6 A
Rated voltage	250 V
Rated impulse voltage	1500 V
Pollution degree	1
Overvoltage category	I
Insulating material group	III
Insulation resistance	≥ 10 ¹⁰ Ω
EMC compliance	shieldable
Degree of protection	IP67
Mechanical operation	> 500 Mating cycles

Material

Contact material	CuSn (bronze)
Contact plating	Ag (silver)
Contact body material	PBT (UL94 V-0)
REACH SVHC	CAS 7439-92-1 (Lead)

authorization/approvals

Approval 1	UL
------------	----

Product description	M16 IP67 female cable connector, Contacts: 5, 6.0 - 8.0 mm, shieldable, screw clamp, IP67, UL
Area	M16 IP67 series 423
Order number	99 5614 210 05

Component part drawing

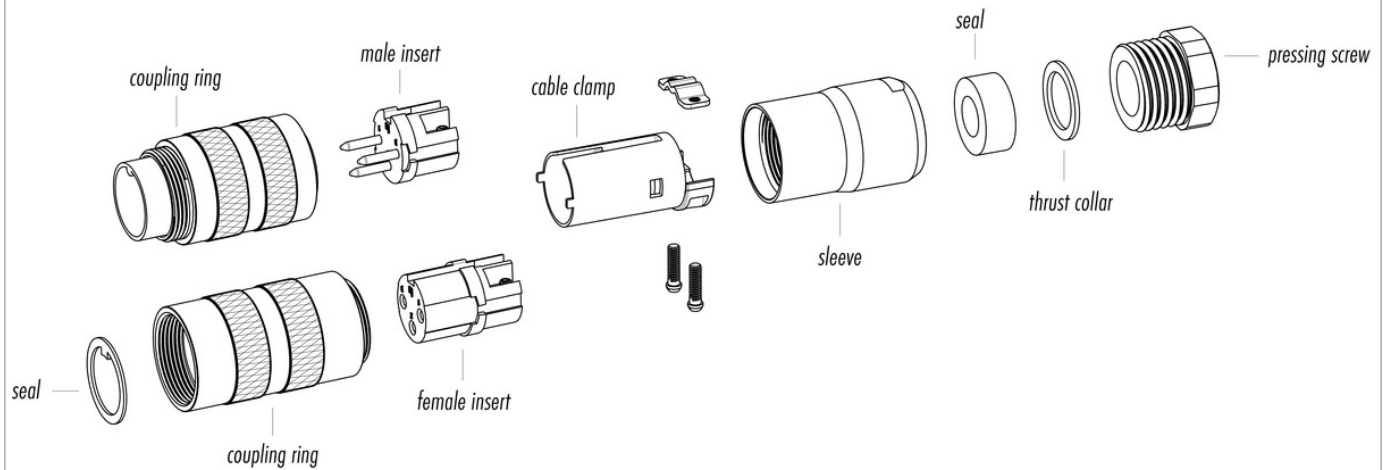

Product description	M16 IP67 female cable connector, Contacts: 5, 6.0 - 8.0 mm, shieldable, screw clamp, IP67, UL
Area	M16 IP67 series 423
Order number	99 5614 210 05

Security notices

The connector must not be plugged or unplugged under load. Non-observance and improper use can result in personal injury.

The connectors have been developed for applications in plant engineering, control and electrical equipment construction. The user is responsible for checking whether the connectors can also be used in other areas of application.

Connectors which are used in circuits with voltages dangerous to the touch may only be installed and used by, or under the supervision of, persons with electrical engineering training, taking into account the applicable regulations and standards.

Plug connectors with enclosure protection IP 67 and IP 68 are not suitable for use under water. When used outdoors, the plug connectors must be protected separately against corrosion. For further information on the IP protection classes, please refer to the "Technical Information" download centre. The plug connector is not suitable for mains voltages. Please observe the pollution degree and the overvoltage category. For further information, please refer to the download center "Technical Information".

To lock the cable connector with the device connector, the threaded ring is tightened "hand-tight" (approx. 50 cNm).