

Product description	M12-B female panel mount connector, Contacts: 5, unshielded, dip-solder, IP68, UL, two-part design
Area	M12-B series 766
Order number	99 4442 202 05

Illustration

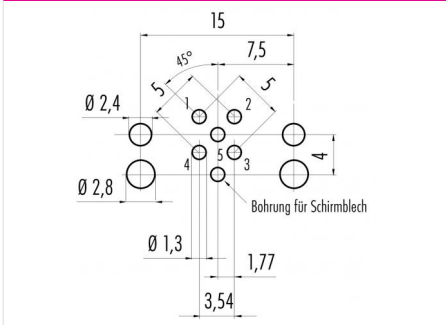

Conductor layout



Scale drawing

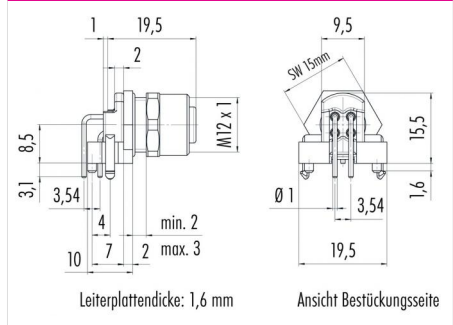

Contact arrangement (Plug-in side)

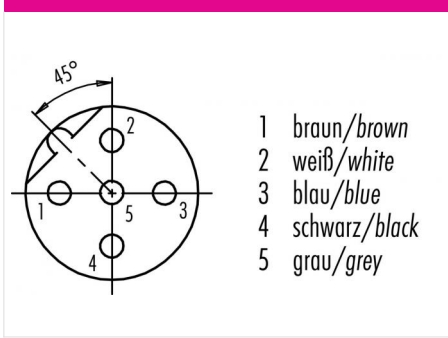

You can find the assembly instructions on the next page.

Technical data

General values

Connector design	female panel mount connector
Connector locking system	screw
Termination	dip-solder
Upper limit temperature	85 °C
Lower limit temperature	-40 °C
Customs tariff number	85369010

Electrical values

Rated current (40 °C)	4 A
Rated voltage	60 V
Rated impulse voltage	1500 V
Pollution degree	3
Overvoltage category	II
Insulating material group	II
Insulation resistance	> 10 ⁸ Ω
EMC compliance	unshielded
Degree of protection	IP68
Mechanical operation	> 100 Mating cycles

Material

Contact material	CuSn (bronze)
Contact plating	Au (gold)
Contact body material	PA
Housing material	CuZn (Brass nickel plated)
REACH SVHC	CAS 7439-92-1 (Lead)

authorization/approvals

Approval 1	UL
------------	----

Product description	M12-B female panel mount connector, Contacts: 5, unshielded, dip-solder, IP68, UL, two-part design
Area	M12-B series 766
Order number	99 4442 202 05

Assembly instructions / Panel cut-out

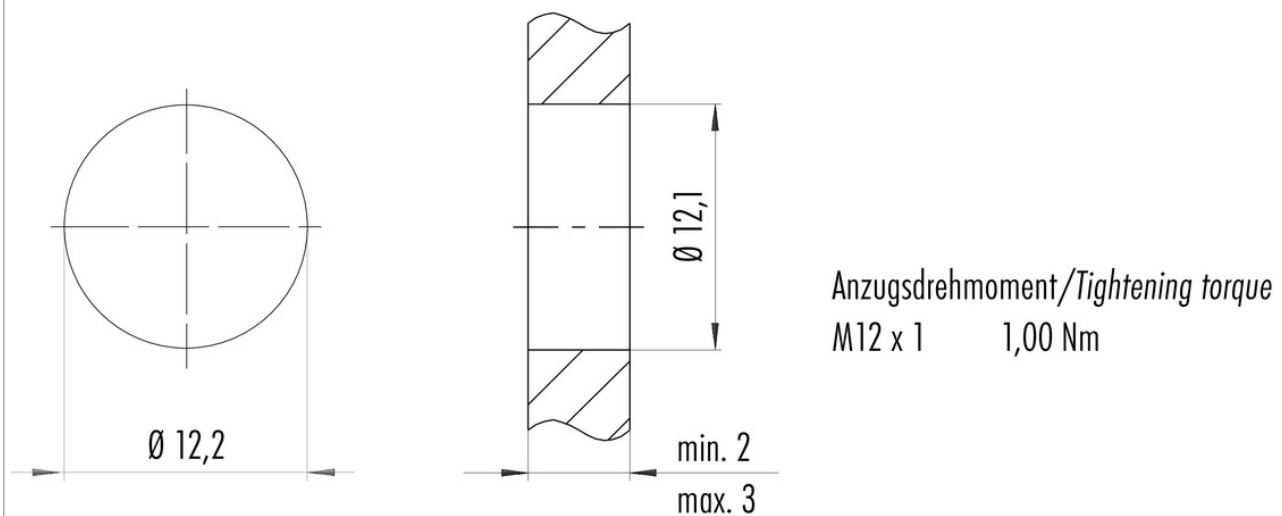

Product description	M12-B female panel mount connector, Contacts: 5, unshielded, dip-solder, IP68, UL, two-part design
Area	M12-B series 766
Order number	99 4442 202 05

Security notices

The connectors have been developed for applications in plant engineering, control and electrical equipment construction. The user is responsible for checking whether the connectors can also be used in other areas of application.

Plug connectors with enclosure protection IP 67 and IP 68 are not suitable for use under water. When used outdoors, the plug connectors must be protected separately against corrosion. For further information on the IP protection classes, please refer to the "Technical Information" download centre.