

Product description	M9 IP40 male cable connector, Contacts: 5, 4.0 - 5.0 mm, unshielded, solder, IP40
Area	M9 IP40 series 711
Order number	99 0095 102 05

Illustration	Scale drawing	Contact arrangement (Plug-in side)

You can find the component part drawing on the next page.

Technical data

General values

Connector design	male cable connector
Connector locking system	screw
Termination	solder
Wire gauge (mm)	max. 0.25 mm ²
Wire gauge (AWG)	max. AWG 24
Cable outlet	4.0 - 5.0 mm
Upper limit temperature	85 °C
Lower limit temperature	-40 °C
Customs tariff number	85369010

Electrical values

Rated current (40 °C)	3 A
Rated voltage	125 V
Rated impulse voltage	1500 V
Pollution degree	1
Overvoltage category	II
Insulating material group	III
Insulation resistance	≥ 10 ¹⁰ Ω
EMC compliance	unshielded
Degree of protection	IP40
Mechanical operation	> 500 Mating cycles

Material

Contact material	CuZn (brass)
Contact plating	Au (gold)
Contact body material	PA (UL94 V-0)
Housing material	PA
Locking material	CuZn (Brass nickel plated)
REACH SVHC	CAS 7439-92-1 (Lead)

Product description M9 IP40 male cable connector, Contacts: 5, 4.0 - 5.0 mm, unshielded, solder, IP40

Area M9 IP40 series 711
Order number 99 0095 102 05

Component part drawing

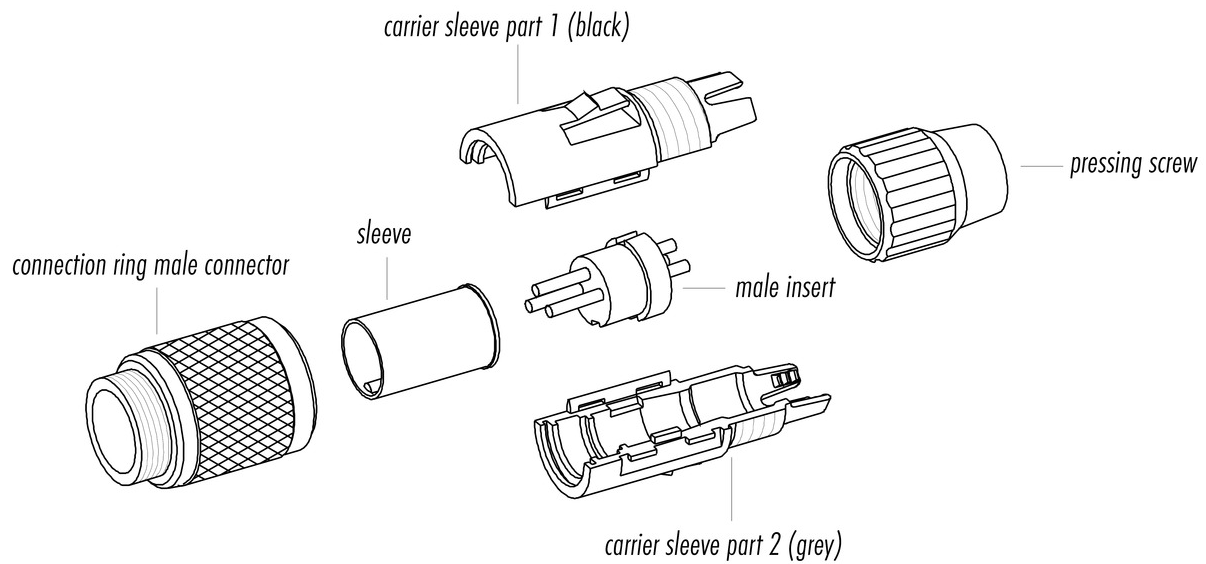

Attention: max. torque of ring nut in socket connector: 50cNm (manual adjustment)

Product description	M9 IP40 male cable connector, Contacts: 5, 4.0 - 5.0 mm, unshielded, solder, IP40
Area	M9 IP40 series 711
Order number	99 0095 102 05

Security notices

The connector must not be plugged or unplugged under load. Non-observance and improper use can result in personal injury.

The connectors have been developed for applications in plant engineering, control and electrical equipment construction. The user is responsible for checking whether the connectors can also be used in other areas of application.

Connectors which are used in circuits with voltages dangerous to the touch may only be installed and used by, or under the supervision of, persons with electrical engineering training, taking into account the applicable regulations and standards.

To lock the cable connector with the device connector, the threaded ring is tightened "hand-tight" (approx. 50 cNm).