

Product description	M12-X connecting cord, Contacts: 8, shielded, moulded on cable, IP67, UL listed, PUR green, AWG 26/7
Area	M12-X series 876
Order number	79 9723 020 08

Illustration

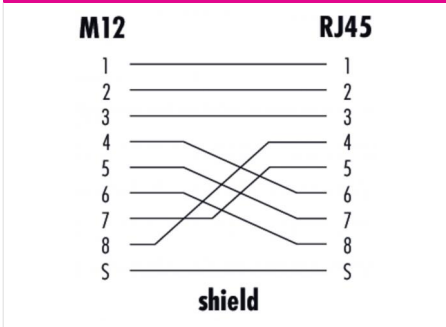

Cable design



Scale drawing

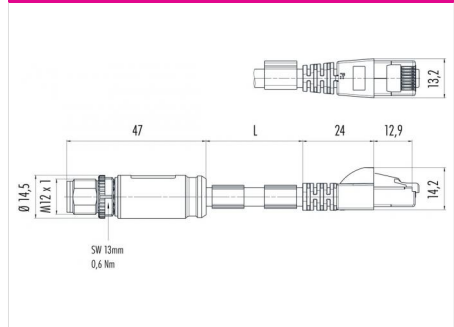

Contact arrangement (Plug-in side)

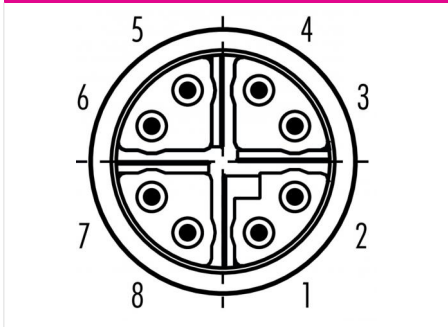

Technical data

General values

Connector design	connecting cord
Connector locking system	screw
Termination	moulded on cable
Wire gauge (AWG)	AWG 26/7
Upper limit temperature	85 °C
Lower limit temperature	-40 °C
category	CAT 6A
Customs tariff number	85444290

Electrical values

Rated current (40 °C)	0.5 A
Rated voltage	50 V AC / 60 V DC V
Pollution degree	3
Overvoltage category	II
Insulating material group	II
Insulation resistance	> 10 ⁸ Ω
EMC compliance	shielded
Degree of protection	IP67
Mechanical operation	RJ45: IP20 > 100 Mating cycles

Material

Contact material	CuZn (brass)
Contact plating	Au (gold)
Contact body material	PA
Housing material	PUR
Locking material	Zinc die-cast nickel-plated

authorization/approvals



Automation technology - data transmission and power supply



Product description	M12-X connecting cord, Contacts: 8, shielded, moulded on cable, IP67, UL listed, PUR green, AWG 26/7
Area	M12-X series 876
Order number	79 9723 020 08

Approval 1

UL listed

Product description	M12-X connecting cord, Contacts: 8, shielded, moulded on cable, IP67, UL listed, PUR green, AWG 26/7
Area	M12-X series 876
Order number	79 9723 020 08

Technical data

Cable data

Cable length	2 m
Sheath material	PUR
Single-lead insulation	PE
Halogen free	Yes
Single-lead structure	8 x 0,14 mm
Cable diameter	6.2 mm
Cable color	green
Conductor resistance	14,5Ω/100 m
Temperature range, moving cable, °C from	-40 °C
Temperature range, moving cable, °C to	60 °C
Temperature range, fixed cable, °C from	-40 °C
Temperature range, fixed cable, °C to	85 °C
Bending radius, fixed cable	≥ 50 mm

Product description	M12-X connecting cord, Contacts: 8, shielded, moulded on cable, IP67, UL listed, PUR green, AWG 26/7
Area	M12-X series 876
Order number	79 9723 020 08

Security notices

The connectors have been developed for applications in plant engineering, control and electrical equipment construction. The user is responsible for checking whether the connectors can also be used in other areas of application.

Plug connectors with enclosure protection IP 67 and IP 68 are not suitable for use under water. When used outdoors, the plug connectors must be protected separately against corrosion. For further information on the IP protection classes, please refer to the "Technical Information" download centre. To lock the cable connector with the device connector, the threaded ring is tightened "hand-tight" (approx. 50 cNm).