

Product description	Size A connecting cord, Contacts: 2+2PE, unshielded, screw clamp, IP67, PUR black, 3 x 0.75 mm ²
Area	Size A series Z10
Order number	79 5704 20 03

Illustration

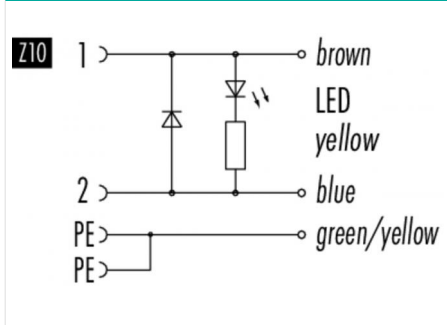

Cable design



Scale drawing

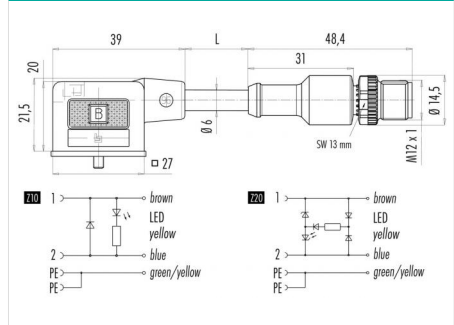

Contact arrangement (Plug-in side)

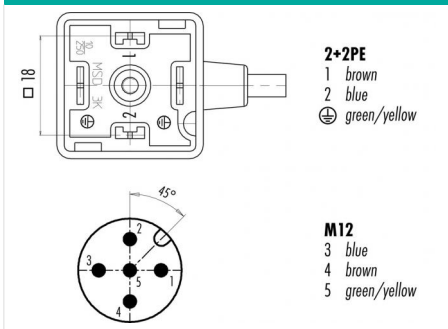

Technical data

General values

Connector design	connecting cord
Connector locking system	central bolt
Termination	screw clamp
Wire gauge (mm)	0.75 mm ²
Wire gauge (AWG)	AWG 18
Upper limit temperature	85 °C
Lower limit temperature	-25 °C
Customs tariff number	85444290

Electrical values

Rated current (40 °C)	4 A
Rated voltage	24 V
Rated impulse voltage	800 V
Pollution degree	3
Overvoltage category	II
Insulating material group	II
Insulation resistance	≥ 10 ¹⁰ Ω
EMC compliance	unshielded
Degree of protection	IP67
Mechanical operation	> 50 Mating cycles
Wiring	Z10

Material

Contact material	CuSn (bronze) / CuZn (brass)
Contact plating	Sn (tin)
Contact body material	PA
Housing material	PC
REACH SVHC	CAS 7439-92-1 (Lead)

Product description	Size A connecting cord, Contacts: 2+2PE, unshielded, screw clamp, IP67, PUR black, 3 x 0.75 mm ²
Area	Size A series 210
Order number	79 5704 20 03

Technical data

Cable data

Cable length	2 m
Sheath material	PUR
Single-lead insulation	PVC
Halogen free	No
Single-lead structure	24x0,2 mm
Cable diameter	6.0 mm
Cable color	black
Temperature range, moving cable, °C from	-5°C
Temperature range, moving cable, °C to	+70°C
Temperature range, fixed cable, °C from	-25°C
Temperature range, fixed cable, °C to	+70°C

Product description	Size A connecting cord, Contacts: 2+2PE, unshielded, screw clamp, IP67, PUR black, 3 x 0.75 mm ²
Area	Size A series 210
Order number	79 5704 20 03

Security notices

The connectors have been developed for applications in plant engineering, control and electrical equipment construction. The user is responsible for checking whether the connectors can also be used in other areas of application.

Plug connectors with enclosure protection IP 67 and IP 68 are not suitable for use under water. When used outdoors, the plug connectors must be protected separately against corrosion. For further information on the IP protection classes, please refer to the "Technical Information" download centre. The user must take appropriate safety precautions to ensure that the connector cannot be accidentally disconnected. In addition, the user must ensure that the cable is suitably secured.