

Product description	M12-A connecting cord, Contacts: 3, unshielded, moulded on cable, IP67, PUR black, 3 x 0.25 mm ²
Area	M12-A series 765
Order number	79 5076 20 03

Illustration

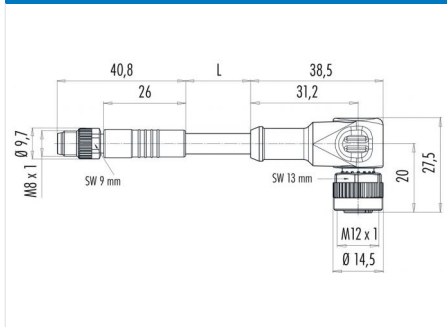

Scale drawing



Contact arrangement (Plug-in side)

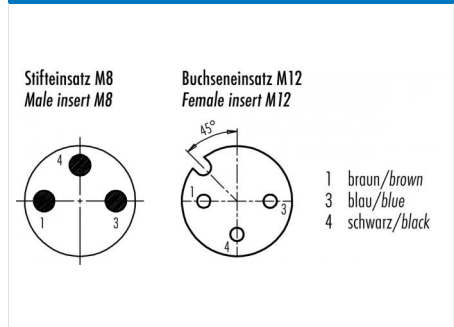

Technical data

General values

Connector design	connecting cord
Connector locking system	screw
Termination	moulded on cable
Wire gauge (mm)	0.25 mm ²
Wire gauge (AWG)	AWG 24
Upper limit temperature	85 °C
Lower limit temperature	-25 °C
Customs tariff number	85444290

Electrical values

Rated current (40 °C)	4 A
Rated voltage	30 V
Rated impulse voltage	800 V
Pollution degree	3
Overvoltage category	II
Insulating material group	II
EMC compliance	unshielded
Degree of protection	IP67
Mechanical operation	> 100 Mating cycles

Cable data

Cable length	2 m
Sheath material	PUR
Single-lead insulation	PVC
Halogen free	No
Single-lead structure	32x0.1 mm
Cable diameter	4.5 mm
Cable color	black
Conductor resistance	72
Temperature range, moving cable, °C from	-20 °C
Temperature range, moving cable, °C to	+80 °C
Temperature range, fixed cable, °C from	-40 °C
Temperature range, fixed cable, °C to	+80 °C
Bending radius, fixed cable	≥ 10 x Ø

Material

Contact material	Pin: CuZn (brass) / Socket: CuSn (bronze)
Contact plating	Au (gold)
Contact body material	PUR
Housing material	PUR
Locking material	Zinc die-cast nickel-plated
REACH SVHC	CAS 7439-92-1 (Lead)

Product description	M12-A connecting cord, Contacts: 3, unshielded, moulded on cable, IP67, PUR black, 3 x 0.25 mm ²
Area	M12-A series 765
Order number	79 5076 20 03

Security notices

The connectors have been developed for applications in plant engineering, control and electrical equipment construction. The user is responsible for checking whether the connectors can also be used in other areas of application.

Plug connectors with enclosure protection IP 67 and IP 68 are not suitable for use under water. When used outdoors, the plug connectors must be protected separately against corrosion. For further information on the IP protection classes, please refer to the "Technical Information" download centre. To lock the cable connector with the device connector, the threaded ring is tightened "hand-tight" (approx. 60 cNm).