

Product description	Size A male connector (panel mount), Contacts: 3+PE, solder, IP40 without seal, UL, ESTI+, VDE
Area	Size A series 210
Order number	43 1711 000 04

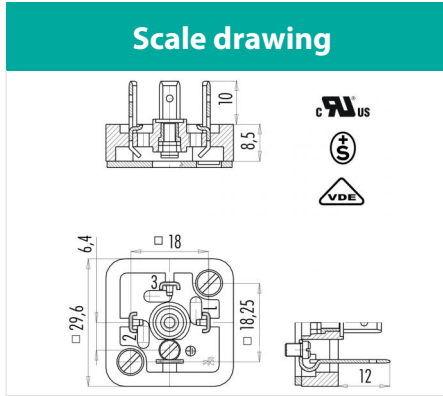

Technical data

General values

Connector design	male connector (panel mount)
Connector locking system	central bolt
Termination	solder
Wire gauge (mm)	1.00 mm ²
Wire gauge (AWG)	AWG 17
Upper limit temperature	100 °C
Lower limit temperature	-25 °C
Customs tariff number	85369010

Electrical values

Rated current (40 °C)	10 A
Rated voltage	250 V
Rated impulse voltage	4000 V
Pollution degree	3
Overvoltage category	III
Insulating material group	III
Insulation resistance	≥ 10 ¹⁰ Ω
Degree of protection	IP40 without seal IP65 with seal, see accessories
Mechanical operation	> 50 Mating cycles

Material

Contact material	CuZn (brass)
Contact plating	Sn (tin)
Contact body material	PA (UL94 HB)
REACH SVHC	CAS 7439-92-1 (Lead)

authorization/approvals

Approval 1	UL
Approval 2	ESTI+
Approval 3	VDE

Product description	Size A male connector (panel mount), Contacts: 3+PE, solder, IP40 without seal, UL, ESTI+, VDE
Area	Size A series 210
Order number	43 1711 000 04

Security notices

The connector must not be plugged or unplugged under load. Non-observance and improper use can result in personal injury.

The connectors have been developed for applications in plant engineering, control and electrical equipment construction. The user is responsible for checking whether the connectors can also be used in other areas of application.

Connectors which are used in circuits with voltages dangerous to the touch may only be installed and used by, or under the supervision of, persons with electrical engineering training, taking into account the applicable regulations and standards.

Plug connectors with enclosure protection IP 67 and IP 68 are not suitable for use under water. When used outdoors, the plug connectors must be protected separately against corrosion. For further information on the IP protection classes, please refer to the "Technical Information" download centre.