

Product description	Push-Pull female panel mount connector, Contacts: 5, unshielded, solder, IP67, front mounting
Area	Push-Pull series 430
Order number	09 4916 080 05

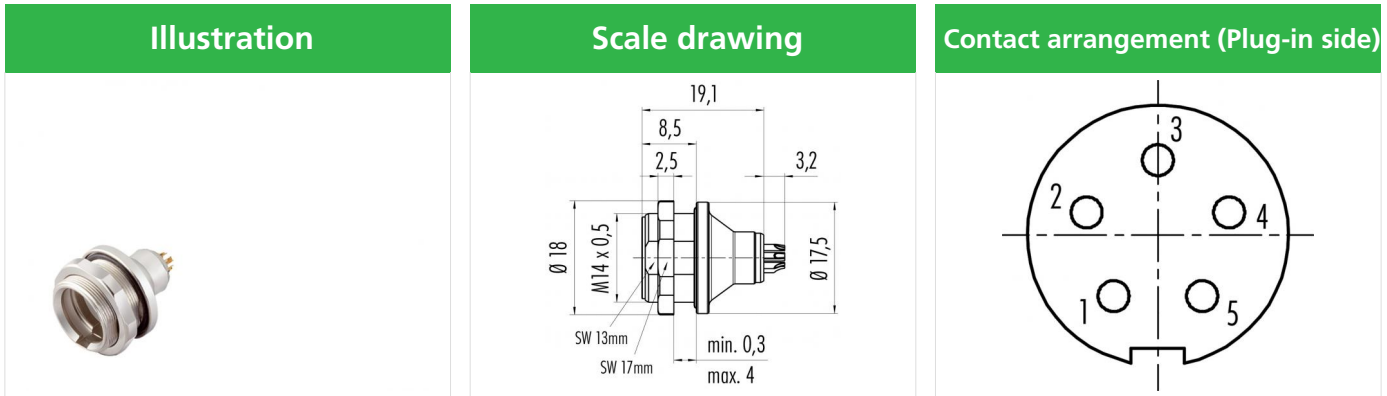

You can find the assembly instructions on the next page.

Technical data

General values

Connector design	female panel mount connector
Connector locking system	Push-Pull
Termination	solder
Wire gauge (mm)	0.25 mm ²
Wire gauge (AWG)	AWG 24
Upper limit temperature	85 °C
Lower limit temperature	-40 °C
Customs tariff number	85369010

Electrical values

Rated current (40 °C)	3 A
Rated voltage	125 V
Rated impulse voltage	1500 V
Pollution degree	2
Overvoltage category	I
Insulating material group	II
EMC compliance	unshielded
Degree of protection	IP67
Mechanical operation	> 500 Mating cycles

Material

Contact material	CuSn (bronze)
Contact plating	Au (gold)
Contact body material	PUR/PA
REACH SVHC	CAS 7439-92-1 (Lead)

Product description	Push-Pull female panel mount connector, Contacts: 5, unshielded, solder, IP67, front mounting
Area	Push-Pull series 430
Order number	09 4916 080 05

Assembly instructions / Panel cut-out

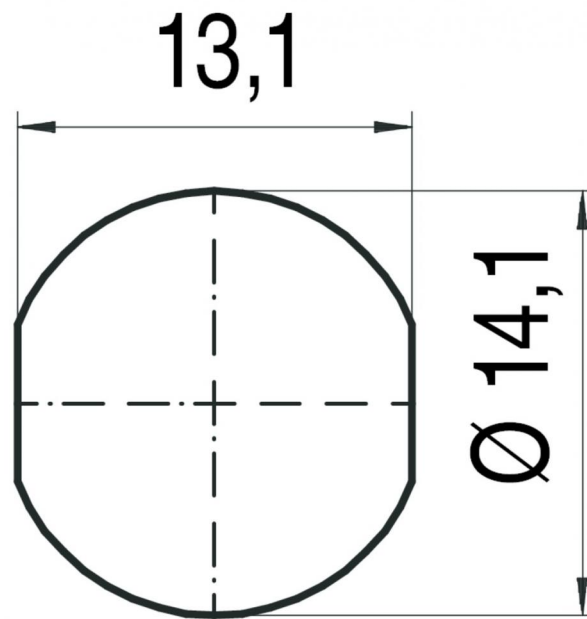

Product description	Push-Pull female panel mount connector, Contacts: 5, unshielded, solder, IP67, front mounting
Area	Push-Pull series 430
Order number	09 4916 080 05

Security notices

The connector must not be plugged or unplugged under load. Non-observance and improper use can result in personal injury.

The connectors have been developed for applications in plant engineering, control and electrical equipment construction. The user is responsible for checking whether the connectors can also be used in other areas of application.

Connectors which are used in circuits with voltages dangerous to the touch may only be installed and used by, or under the supervision of, persons with electrical engineering training, taking into account the applicable regulations and standards.

Plug connectors with enclosure protection IP 67 and IP 68 are not suitable for use under water. When used outdoors, the plug connectors must be protected separately against corrosion. For further information on the IP protection classes, please refer to the "Technical Information" download centre.