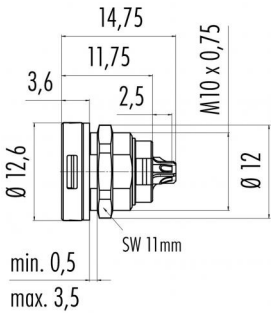
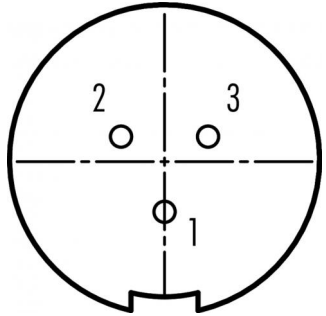

Product description	Push-Pull female panel mount connector, Contacts: 3, unshielded, solder, IP67
Area	Push-Pull series 420
Order number	09 4708 00 03

Illustration	Scale drawing	Contact arrangement (Plug-in side)
		

You can find the component part drawing and assembly instructions on the next page.

Technical data

General values

Connector design	female panel mount connector
Connector locking system	Micro Push-Pull
Termination	solder
Wire gauge (mm)	0.14 mm ²
Wire gauge (AWG)	AWG 26
Upper limit temperature	80 °C
Lower limit temperature	-40 °C
Customs tariff number	85369010

Electrical values

Rated current (40 °C)	1 A
Rated voltage	125 V
Rated impulse voltage	1500 V
Pollution degree	2
Overvoltage category	II
Insulating material group	II
EMC compliance	unshielded
Degree of protection	IP67
Mechanical operation	> 1000 Mating cycles

Material

Contact material	CuSn (bronze)
Contact plating	Au (gold)
Contact body material	PA
Housing material	PA
REACH SVHC	CAS 7439-92-1 (Lead)

Product description	Push-Pull female panel mount connector, Contacts: 3, unshielded, solder, IP67
Area	Push-Pull series 420
Order number	09 4708 00 03

Component part drawing

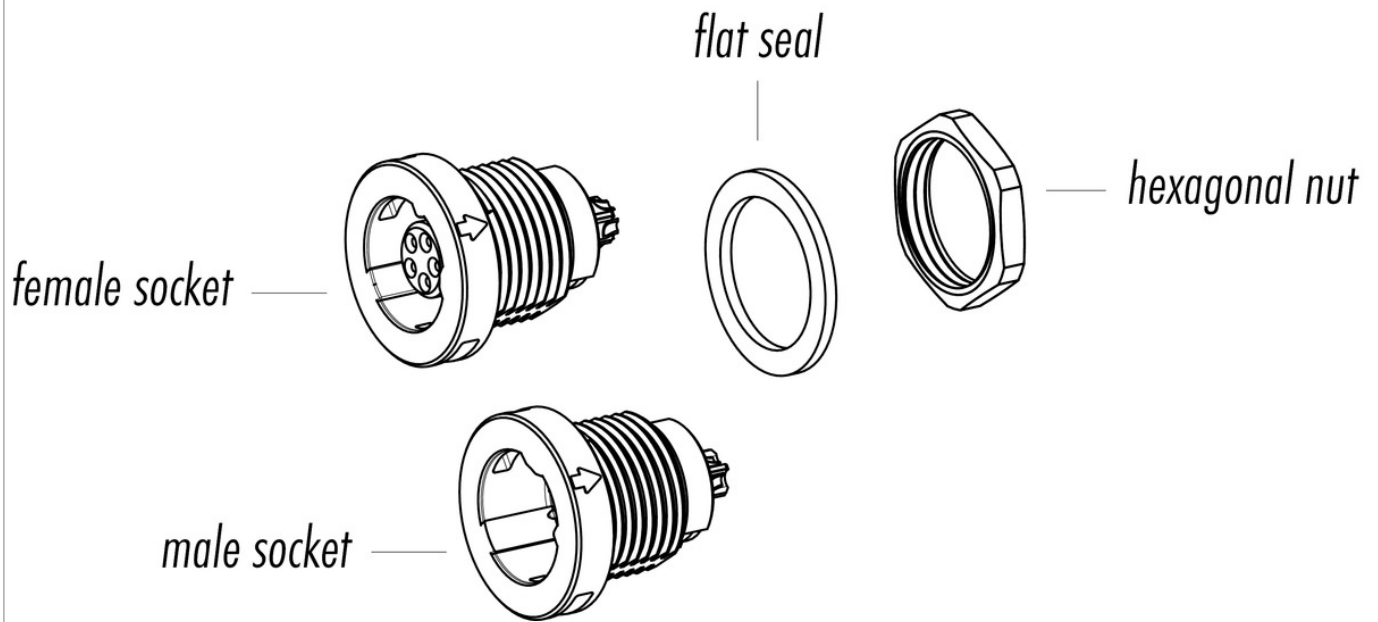

Assembly instructions / Panel cut-out

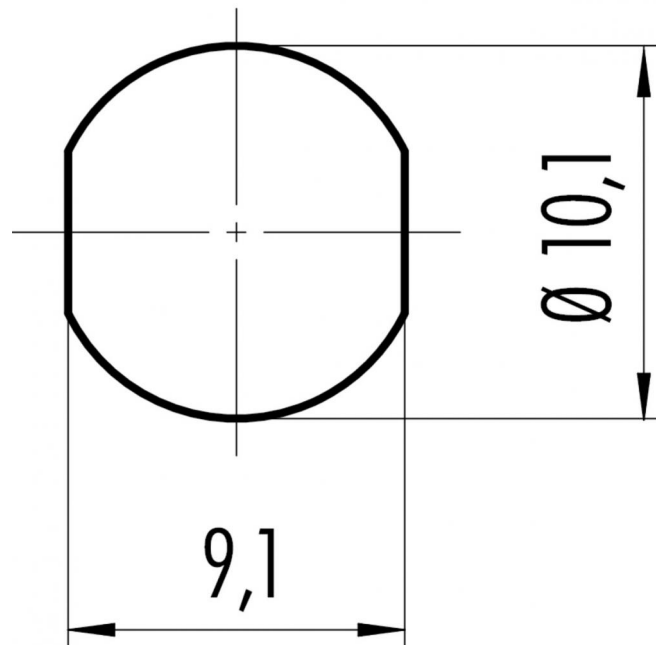

Product description	Push-Pull female panel mount connector, Contacts: 3, unshielded, solder, IP67
Area	Push-Pull series 420
Order number	09 4708 00 03

Security notices

The connector must not be plugged or unplugged under load. Non-observance and improper use can result in personal injury.

The connectors have been developed for applications in plant engineering, control and electrical equipment construction. The user is responsible for checking whether the connectors can also be used in other areas of application.

Connectors which are used in circuits with voltages dangerous to the touch may only be installed and used by, or under the supervision of, persons with electrical engineering training, taking into account the applicable regulations and standards.

Plug connectors with enclosure protection IP 67 and IP 68 are not suitable for use under water. When used outdoors, the plug connectors must be protected separately against corrosion. For further information on the IP protection classes, please refer to the "Technical Information" download centre.