

Product description	M12-T female panel mount connector, Contacts: 4, unshielded, single wires, IP68, UL, VDE, M16x1.5
Area	M12-T series 813
Order number	09 0632 700 04

Illustration

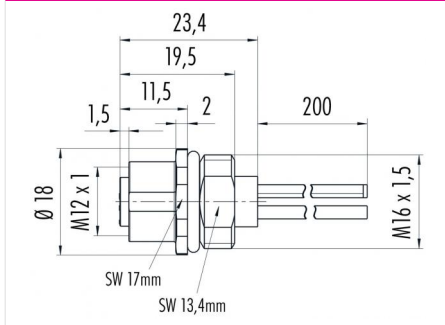

Scale drawing



Contact arrangement (Plug-in side)

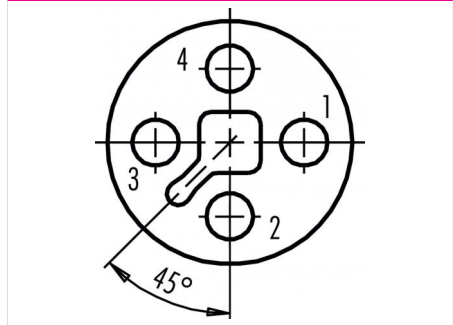

You can find the assembly instructions on the next page.

Technical data

General values

Connector design	female panel mount connector
Connector locking system	screw
Termination	single wires
Wire gauge (mm)	1.38 mm ²
Wire gauge (AWG)	AWG 16
Upper limit temperature	85 °C
Lower limit temperature	-40 °C
Customs tariff number	85369010

Electrical values

Rated current (40 °C)	12 A
Rated voltage	63 V
Rated impulse voltage	1500 V
Pollution degree	3
Overvoltage category	III
Insulating material group	II
EMC compliance	unshielded
Degree of protection	IP68
Mechanical operation	> 100 Mating cycles

Material

Contact material	CuSn (bronze)
Contact plating	Au (gold)
Contact body material	PA
Housing material	Zinc die-cast nickel-plated
REACH SVHC	CAS 7439-92-1 (Lead)

authorization/approvals

Approval 1	UL
Approval 2	VDE

Product description M12-T female panel mount connector, Contacts: 4, unshielded, single wires, IP68, UL, VDE, M16x1.5
 Area M12-T series 813
 Order number 09 0632 700 04

Assembly instructions / Panel cut-out

With flats as anti-rotation device

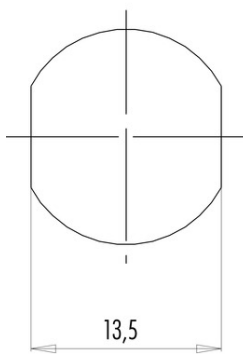

With bore hole

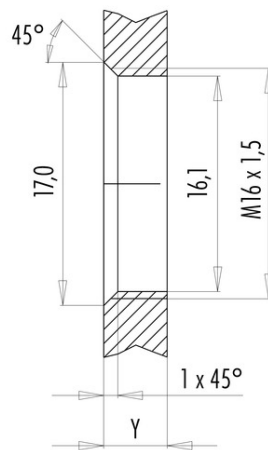

Installation direction: o-ring sits on chamfer.

Tightening moment

Metall housing/Plastic housing 1,25 Nm

Thickness of wall Y (mm)		
Version	min (mm)	max (mm)
Fastened from rear	2	3,5
Front fastened	2	4,5
positioning possible ¹⁾	2	3,5
Screw clamp	2	3,5
Thread M12 x 1	2	3,0
Thread M14 x 1 ²⁾	³⁾ 1,5/ ⁴⁾ 2	6,5

Notes

- ¹⁾ Do not attach a chamfer
- ²⁾ Wall thickness:
use locknut 01-5385 up to 1,5 mm,
>1,5 mm cut thread
- ³⁾ Nut
- ⁴⁾ Thread in wall of housing

Product description	M12-T female panel mount connector, Contacts: 4, unshielded, single wires, IP68, UL, VDE, M16x1.5
Area	M12-T series 813
Order number	09 0632 700 04

Security notices

The connectors have been developed for applications in plant engineering, control and electrical equipment construction. The user is responsible for checking whether the connectors can also be used in other areas of application.

Plug connectors with enclosure protection IP 67 and IP 68 are not suitable for use under water. When used outdoors, the plug connectors must be protected separately against corrosion. For further information on the IP protection classes, please refer to the "Technical Information" download centre.