

Product description **M9 IP67 male panel mount connector, Contacts: 5, unshielded, solder, IP67**
 Area **M9 IP67 series 712**
 Order number **09 0415 00 05**

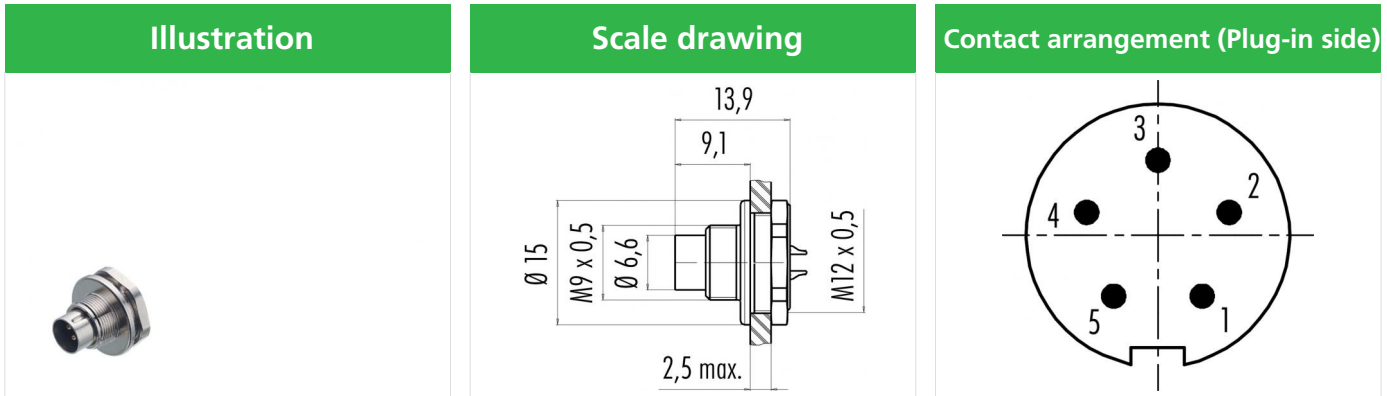

You can find the assembly instructions on the next page.

Technical data

General values

Connector design	male panel mount connector
Connector locking system	screw
Termination	solder
Wire gauge (mm)	0.25 mm ²
Wire gauge (AWG)	AWG 24
Upper limit temperature	85 °C
Lower limit temperature	-40 °C
Customs tariff number	85369010

Electrical values

Rated current (40 °C)	3 A
Rated voltage	125 V
Rated impulse voltage	1500 V
Pollution degree	1
Overvoltage category	II
Insulating material group	III
Insulation resistance	$\geq 10^{10} \Omega$
EMC compliance	unshielded
Degree of protection	IP67
Mechanical operation	> 500 Mating cycles

Material

Contact material	CuZn (brass)
Contact plating	Au (gold)
Contact body material	PA (UL94 V-0)
Housing material	CuZn (Brass nickel plated)
REACH SVHC	CAS 7439-92-1 (Lead)

Product description	M9 IP67 male panel mount connector, Contacts: 5, unshielded, solder, IP67
Area	M9 IP67 series 712
Order number	09 0415 00 05

Assembly instructions / Panel cut-out

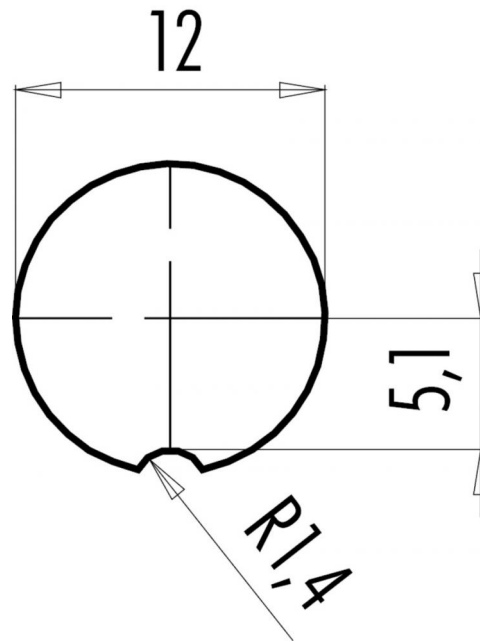

Product description	M9 IP67 male panel mount connector, Contacts: 5, unshielded, solder, IP67
Area	M9 IP67 series 712
Order number	09 0415 00 05

Security notices

The connector must not be plugged or unplugged under load. Non-observance and improper use can result in personal injury.

The connectors have been developed for applications in plant engineering, control and electrical equipment construction. The user is responsible for checking whether the connectors can also be used in other areas of application.

Plug connectors with enclosure protection IP 67 and IP 68 are not suitable for use under water. When used outdoors, the plug connectors must be protected separately against corrosion. For further information on the IP protection classes, please refer to the "Technical Information" download centre.