

Product description	M16 IP40 female panel mount connector, Contacts: 19, unshielded, dip-solder, IP40, front mounting
Area	M16 IP40 series 680
Order number	09 0336 90 19

**Illustration**

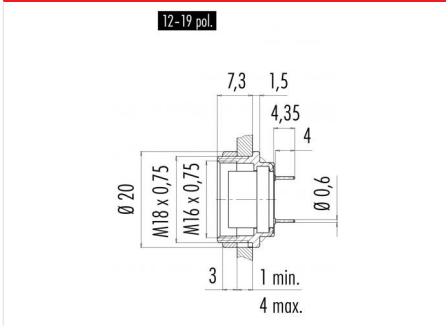

**Scale drawing**



**Contact arrangement (Plug-in side)**

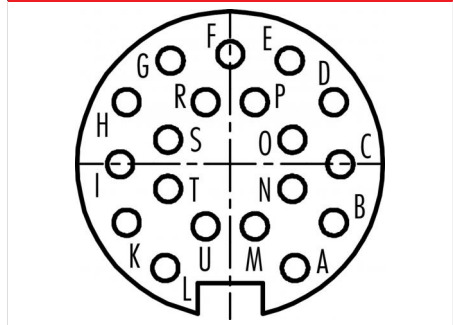

You can find the assembly instructions on the next page.

**Technical data**

**General values**

Connector design	female panel mount connector
Connector locking system	screw
Termination	dip-solder
Upper limit temperature	85 °C
Lower limit temperature	-40 °C
Customs tariff number	85369010

**Electrical values**

Rated current (40 °C)	3 A
Rated voltage	60 V
Rated impulse voltage	500 V
Pollution degree	1
Overvoltage category	I
Insulating material group	III
Insulation resistance	≥ 10 <sup>10</sup> Ω
EMC compliance	unshielded
Degree of protection	IP40
Mechanical operation	> 500 Mating cycles

**Material**

Contact material	CuSn (bronze)
Contact plating	Au (gold)
Contact body material	PBT (UL94 V-0)
Housing material	Zinc die-cast nickel-plated
REACH SVHC	CAS 7439-92-1 (Lead)

Product description M16 IP40 female panel mount connector, Contacts: 19, unshielded, dip-solder, IP40, front mounting

Area M16 IP40 series 680  
Order number 09 0336 90 19

Assembly instructions / Panel cut-out



Product description	<b>M16 IP40 female panel mount connector, Contacts: 19, unshielded, dip-solder, IP40, front mounting</b>
Area	<b>M16 IP40 series 680</b>
Order number	<b>09 0336 90 19</b>

## Security notices

The connectors have been developed for applications in plant engineering, control and electrical equipment construction. The user is responsible for checking whether the connectors can also be used in other areas of application.