

Product description	M16 IP40 female panel mount connector, Contacts: 4, unshielded, dip-solder, IP40, front mounting
Area	M16 IP40 series 680
Order number	09 0312 90 04

Illustration

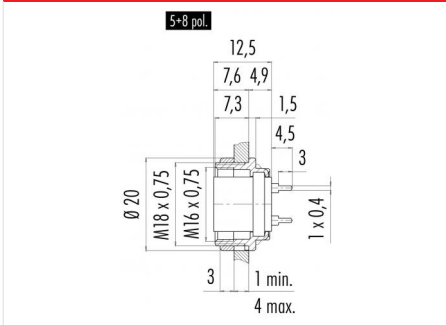

Scale drawing



Contact arrangement (Plug-in side)

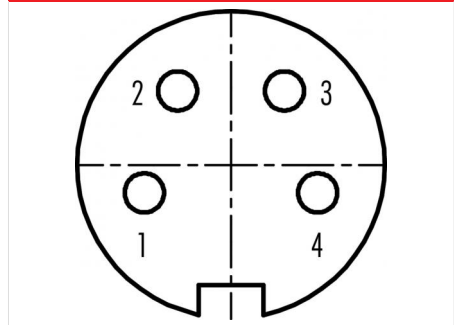

You can find the assembly instructions on the next page.

Technical data

General values

Connector design	female panel mount connector
Connector locking system	screw
Termination	dip-solder
Upper limit temperature	85 °C
Lower limit temperature	-40 °C
Customs tariff number	85369010

Electrical values

Rated current (40 °C)	6 A
Rated voltage	250 V
Rated impulse voltage	1500 V
Pollution degree	1
Overvoltage category	I
Insulating material group	III
Insulation resistance	≥ 10 ¹⁰ Ω
EMC compliance	unshielded
Degree of protection	IP40
Mechanical operation	> 500 Mating cycles

Material

Contact material	CuSn (bronze)
Contact plating	Ag (silver)
Contact body material	PBT (UL94 V-0)
Housing material	Zinc die-cast nickel-plated
REACH SVHC	CAS 7439-92-1 (Lead)

Product description M16 IP40 female panel mount connector, Contacts: 4, unshielded, dip-solder, IP40, front mounting

Area M16 IP40 series 680
Order number 09 0312 90 04

Assembly instructions / Panel cut-out

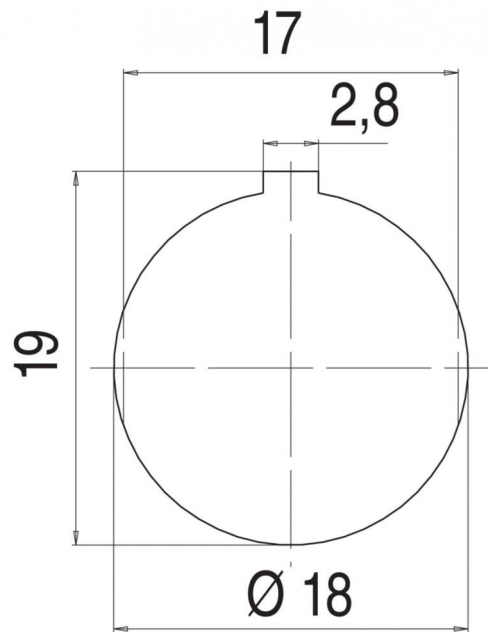

Product description	M16 IP40 female panel mount connector, Contacts: 4, unshielded, dip-solder, IP40, front mounting
Area	M16 IP40 series 680
Order number	09 0312 90 04

Security notices

The connector must not be plugged or unplugged under load. Non-observance and improper use can result in personal injury.

The connectors have been developed for applications in plant engineering, control and electrical equipment construction. The user is responsible for checking whether the connectors can also be used in other areas of application.

To protect against unintentional opening of the connector, the thread between the housing and the connector head must be secured with a suitable cyanoacrylate adhesive when used in circuits with voltages dangerous to the touch. This does not apply to connectors used in SELV and PELV circuits according to IEC 61140 (EN 61140, VDE 0140-1).

The plug connector is not suitable for mains voltages. Please observe the pollution degree and the overvoltage category. For further information, please refer to the download center "Technical Information".