

Product description	M16 IP67 square male panel mount connector, Contacts: 5, unshielded, crimp (Crimp contacts must be ordered separately), IP67, UL
Area	M16 IP67 series 723
Order number	09 0115 370 05

Illustration

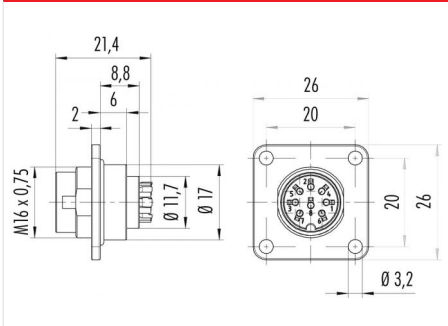

Scale drawing



Contact arrangement (Plug-in side)

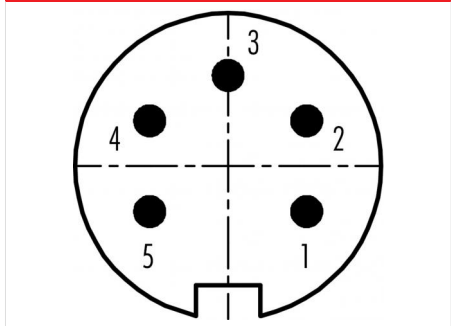

You can find the assembly instructions on the next page.

Technical data

General values

Connector design	square male panel mount connector
Connector locking system	screw
Termination	crimp (Crimp contacts must be ordered separately)
Wire gauge (mm)	see crimp contacts under accessories
Upper limit temperature	100 °C
Lower limit temperature	-40 °C
Customs tariff number	85369010

Electrical values

Rated current (40 °C)	5 A
Rated voltage	250 V
Rated impulse voltage	1500 V
Pollution degree	1
Overvoltage category	I
Insulating material group	III
Insulation resistance	≥ 10 ¹⁰ Ω
EMC compliance	unshielded
Degree of protection	IP67
Mechanical operation	> 500 Mating cycles

Material

Contact material	depending on crimp contact (accessory)
Contact body material	PBT (UL94 V-0)
Housing material	Zinc die-cast nickel-plated
Locking material	Zinc die-cast nickel-plated

authorization/approvals

Approval 1	UL
------------	----

Product description	M16 IP67 square male panel mount connector, Contacts: 5, unshielded, crimp (Crimp contacts must be ordered separately), IP67, UL
Area	M16 IP67 series 723
Order number	09 0115 370 05

Assembly instructions / Panel cut-out

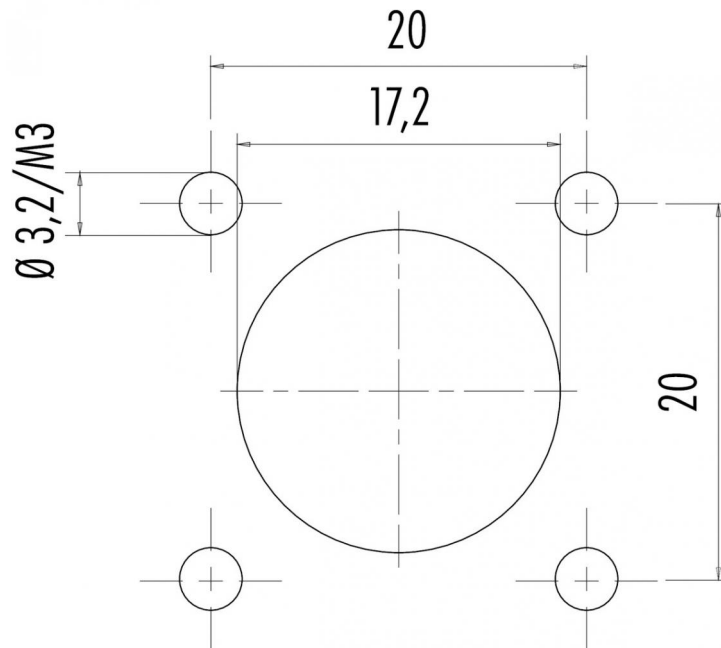

Product description	M16 IP67 square male panel mount connector, Contacts: 5, unshielded, crimp (Crimp contacts must be ordered separately), IP67, UL
Area	M16 IP67 series 723
Order number	09 0115 370 05

Security notices

The connector must not be plugged or unplugged under load. Non-observance and improper use can result in personal injury.

The connectors have been developed for applications in plant engineering, control and electrical equipment construction. The user is responsible for checking whether the connectors can also be used in other areas of application.

Plug connectors with enclosure protection IP 67 and IP 68 are not suitable for use under water. When used outdoors, the plug connectors must be protected separately against corrosion. For further information on the IP protection classes, please refer to the "Technical Information" download centre. The plug connector is not suitable for mains voltages. Please observe the pollution degree and the overvoltage category. For further information, please refer to the download center "Technical Information".

The protection class specification applies on condition that the four mounting holes are made as blind holes.