

Product description	M25 male cable connector, Contacts: 7, 5.0 - 8.0 mm, shieldable, solder, IP40
Area	M25 series 691
Order number	09 0041 00 07

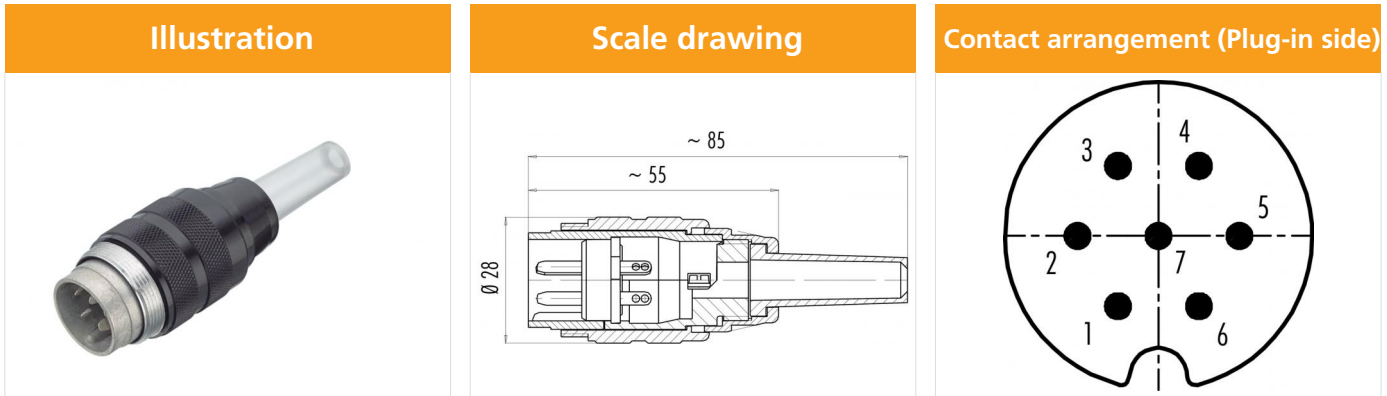

You can find the component part drawing on the next page.

Technical data

General values

Connector design	male cable connector
Connector locking system	screw
Termination	solder
Wire gauge (mm)	0.75 mm ²
Wire gauge (AWG)	AWG 18
Cable outlet	5.0 - 8.0 mm
Upper limit temperature	85 °C
Lower limit temperature	-40 °C
Customs tariff number	85369010

Electrical values

Rated current (40 °C)	5 A
Rated voltage	250 V
Rated impulse voltage	2500 V
Pollution degree	1
Overvoltage category	II
Insulating material group	III
Insulation resistance	≥ 10 ¹⁰ Ω
EMC compliance	shieldable
Degree of protection	IP40
Mechanical operation	> 50 Mating cycles

Material

Contact material	CuZn (brass)
Contact plating	CuSnZn (Optalloy)
Contact body material	PET (UL94 V-0)
Housing material	GD-AL eloxiert
REACH SVHC	CAS 7439-92-1 (Lead)

Product description M25 male cable connector, Contacts: 7, 5.0 - 8.0 mm, shieldable, solder, IP40

Area M25 series 691
Order number 09 0041 00 07

Component part drawing

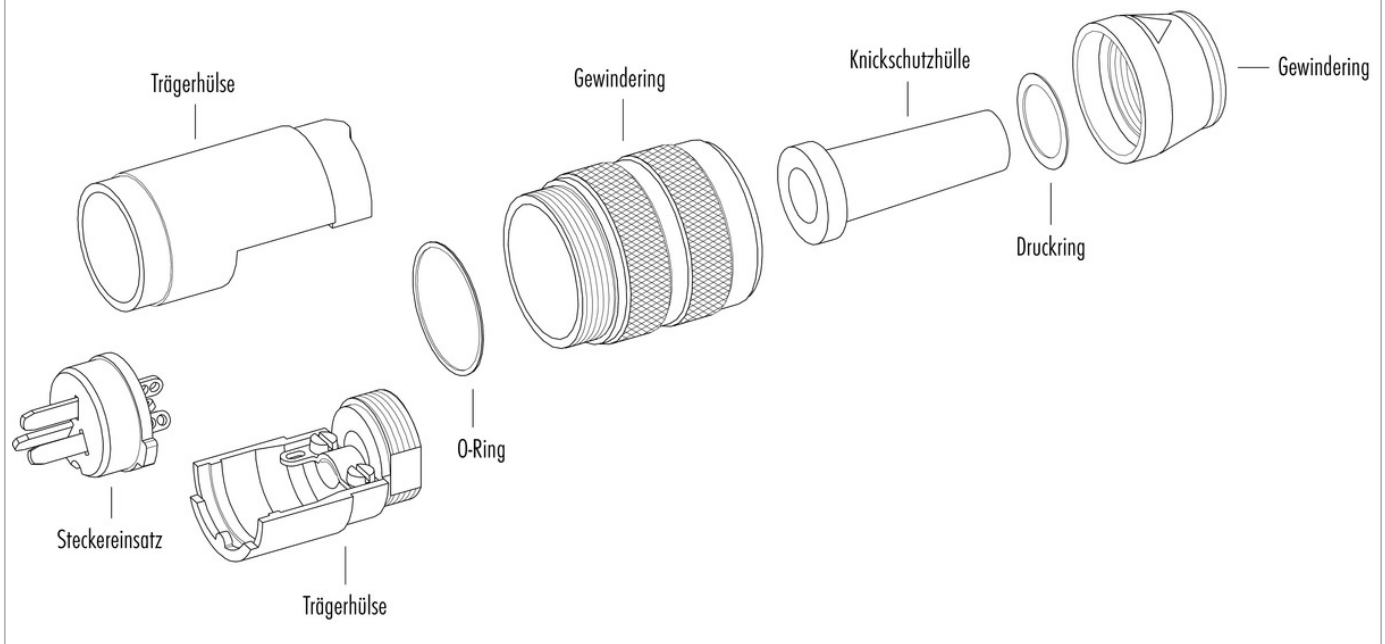

Product description	M25 male cable connector, Contacts: 7, 5.0 - 8.0 mm, shieldable, solder, IP40
Area	M25 series 691
Order number	09 0041 00 07

Security notices

The connector must not be plugged or unplugged under load. Non-observance and improper use can result in personal injury.

The connectors have been developed for applications in plant engineering, control and electrical equipment construction. The user is responsible for checking whether the connectors can also be used in other areas of application.

To protect against unintentional opening of the connector, the thread between the housing and the connector head must be secured with a suitable cyanoacrylate adhesive when used in circuits with voltages dangerous to the touch. This does not apply to connectors used in SELV and PELV circuits according to IEC 61140 (EN 61140, VDE 0140-1).

Connectors which are used in circuits with voltages dangerous to the touch may only be installed and used by, or under the supervision of, persons with electrical engineering training, taking into account the applicable regulations and standards.

To lock the cable connector with the device connector, the threaded ring is tightened "hand-tight" (approx. 50 cNm).