

Product description **M25 female panel mount connector, Contacts: 3, shieldable, solder, IP40**
 Area **M25 series 691**
 Order number **09 0036 00 03**

Illustration

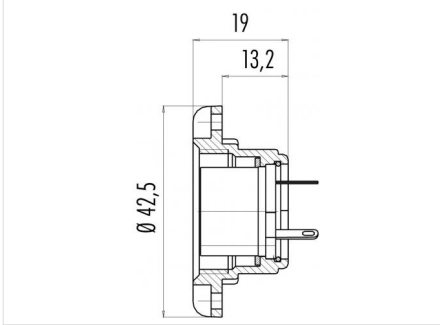

Scale drawing



Contact arrangement (Plug-in side)

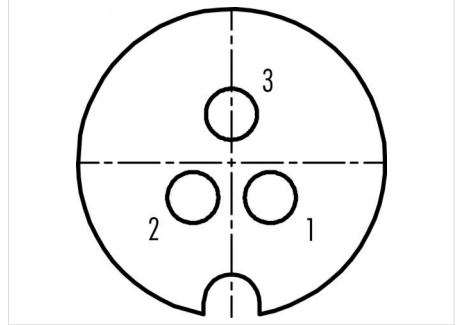

Technical data

General values

Connector design	female panel mount connector
Connector locking system	screw
Termination	solder
Wire gauge (mm)	1.50 mm ²
Wire gauge (AWG)	AWG 16
Upper limit temperature	85 °C
Lower limit temperature	-40 °C
Customs tariff number	85369010

Electrical values

Rated current (40 °C)	10 A
Rated voltage	250 V
Rated impulse voltage	2500 V
Pollution degree	1
Overvoltage category	II
Insulating material group	III
Insulation resistance	≥ 10 ¹⁰ Ω
EMC compliance	shieldable
Degree of protection	IP40
Mechanical operation	> 500 Mating cycles

Material

Contact material	CuSn (bronze)
Contact plating	Ag (silver)
Contact body material	PBT (UL94 V-0)
Housing material	GD-AL eloxiert

Product description **M25 female panel mount connector, Contacts: 3, shieldable, solder, IP40**

Area **M25 series 691**
Order number **09 0036 00 03**

Security notices

The connector must not be plugged or unplugged under load. Non-observance and improper use can result in personal injury.

The connectors have been developed for applications in plant engineering, control and electrical equipment construction. The user is responsible for checking whether the connectors can also be used in other areas of application.

To protect against unintentional opening of the connector, the thread between the housing and the connector head must be secured with a suitable cyanoacrylate adhesive when used in circuits with voltages dangerous to the touch. This does not apply to connectors used in SELV and PELV circuits according to IEC 61140 (EN 61140, VDE 0140-1).

Connectors which are used in circuits with voltages dangerous to the touch may only be installed and used by, or under the supervision of, persons with electrical engineering training, taking into account the applicable regulations and standards.