

Kabelstecker  
Male cable connector

Kabeldose  
Female cable connector

Flanschstecker  
Male panel mount connector

Flanschdose  
Female panel mount connector

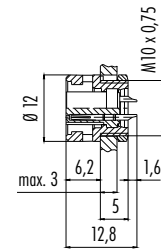
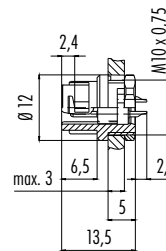
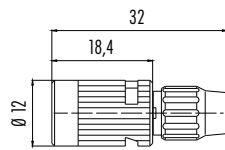
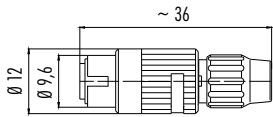

Polzahl Contacts	Kabel-Ø 3–4 mm Cable Ø 3–4 mm	Kabel-Ø 4–5 mm Cable Ø 4–5 mm
2	99 0971 100 02	99 0971 102 02
3	99 0975 100 03	99 0975 102 03
4	99 0979 100 04	99 0979 102 04
5	99 0995 100 05	99 0995 102 05
7	99 9475 100 07	99 9475 102 07
8	99 9479 100 08	99 9479 102 08

Polzahl Contacts	Kabel-Ø 3–4 mm Cable Ø 3–4 mm	Kabel-Ø 4–5 mm Cable Ø 4–5 mm
2	99 0972 100 02	99 0972 102 02
3	99 0976 100 03	99 0976 102 03
4	99 0980 100 04	99 0980 102 04
5	99 0996 100 05	99 0996 102 05
7	99 9476 100 07	99 9476 102 07
8	99 9480 100 08	99 9480 102 08

Polzahl Contacts	Bestell-Nr. Ordering-No.
2	09 0973 00 02
3	09 0977 00 03
4	09 0981 00 04
5	09 0997 00 05
7	09 9477 00 07
8	09 9481 00 08

Polzahl Contacts	Bestell-Nr. Ordering-No.
2	09 0974 00 02
3	09 0978 00 03
4	09 0982 00 04
5	09 0998 00 05
7	09 9478 00 07
8	09 9482 00 08

Polzahl	2	3	4	5	7	8	Number of contacts
Steckverbinder Verriegelung	Bajonett/bayonet						Connector locking system
Anschlussart	löten/solder						Termination
Anschlussquerschnitt	max. 0,25 mm <sup>2</sup> (max. AWG 24)			max. 0,14 mm <sup>2</sup> (max. AWG 26)			Wire gauge
Kabeldurchlass	3–4 mm, 4–5 mm/ —						Cable outlet
Schutzart	IP40						Degree of protection
Mechanische Lebensdauer	> 500 Steckzyklen/> 500 mating cycles						Mechanical operation
Obere Grenztemperatur	+ 85 °C						Upper temperature
Untere Grenztemperatur	– 40 °C						Lower temperature
Bemessungsspannung	125 V						Rated voltage
Bemessungs-Stoßspannung	1500 V						Rated impulse voltage
Verschmutzungsgrad	1						Pollution degree
Überspannungskategorie	II						Overvoltage categorie
Isolierstoffgruppe	III						Material group
Bemessungsstrom (40°C)	4 A		3 A		1 A		Rated current (40 °C)
Material Kontakt	Stift/pin CuZn (Messing/brass), Buchse/socket CuSn (Bronze/bronze)						Material of contact
Kontaktoberfläche	Au (Gold/gold)						Contact plating
Material Kontaktkörper	PA						Material of contact body
Material Gehäuse	PA						Material of housing
Material Verriegelung	PA/ —						Material of locking

Montageanleitung  
Assembly instruction

Kabelstecker  
Male cable connector

1. Druckschraube auf Kabel auffädeln.
2. Kabel abmanteln auf L = 15 mm.
3. Litzen abisolieren und anlöten.
4. Steckereinsatz in Hülse montieren.
5. Hülse mit Steckereinsatz in Trägerhalbschale Unterteil setzen.
6. Trägerhalbschale Oberteil auf Unterteil montieren.
7. Trägerbaugruppe in Gewinding schnappen.
8. Druckschraube festziehen.

1. Bead pressing screw to cable.
2. Dismantle cable to 15 mm length.
3. Strip and solder single wires.
4. Mount male insert into sleeve.
5. Insert sleeve with male insert into carrier sleeve part 2 (lower part grey).
5. Mount carrier sleeve part 1 (upper part black) on carrier sleeve part 2 (lower part grey).
6. Snap assembly group into coupling ring.
7. Tighten pressing screw.

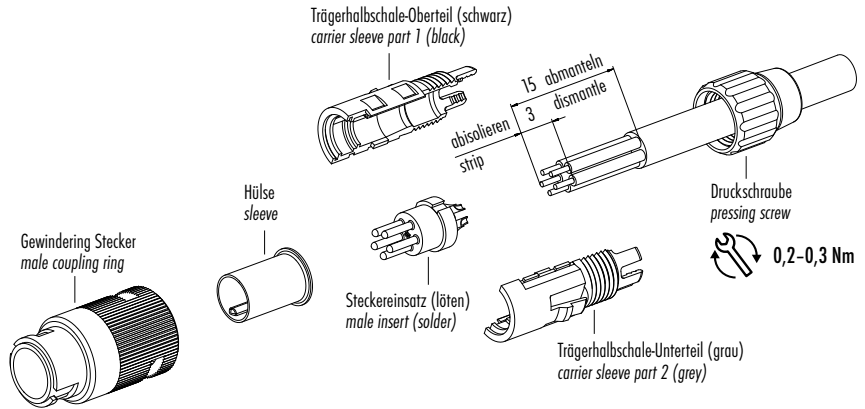

Kabeldose  
Female cable connector

1. Druckschraube auf Kabel auffädeln.
2. Kabel abmanteln auf L = 15 mm.
3. Litzen abisolieren und anlöten.
4. Buchseneinsatz in Trägerhalbschale Unterteil legen.
5. Trägerhalbschale Oberteil auf Unterteil montieren.
6. Trägerbaugruppe in Gewinding schnappen.
7. Druckschraube festziehen.

1. Bead pressing screw to cable.
2. Dismantle cable to 15 mm length.
3. Strip and solder single wires.
4. Place female insert into carrier sleeve part 2 (lower part grey).
4. Mount carrier sleeve part 1 (upper part black) on carrier sleeve part 2 (lower part grey).
5. Snap assembly group into coupling ring.
6. Tighten pressing screw.

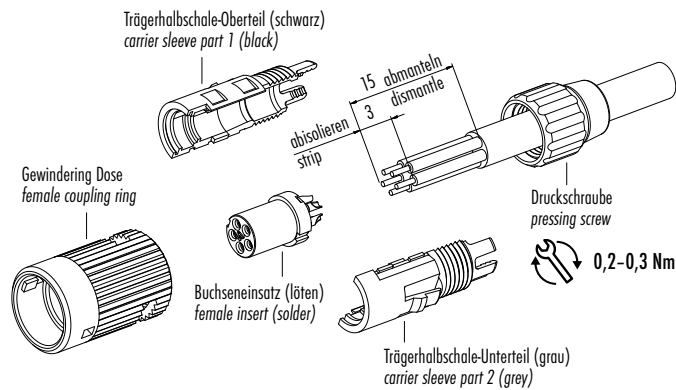

Einzelteildarstellung  
Component part drawing

Flanschsteckverbinder  
Panel mount connectors

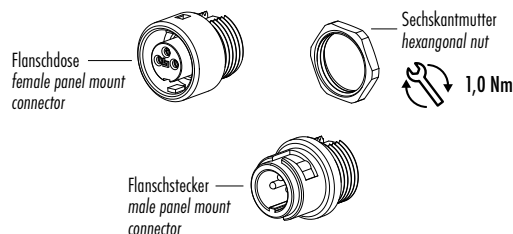

Polbilder  
Contact arrangements

Stifteinsatz (Steckseite)  
Male insert (mating side)

Buchseinsatz (Steckseite)  
Female insert (mating side)

2 pol  
2 contacts

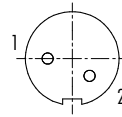
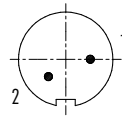

3 pol  
3 contacts

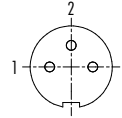
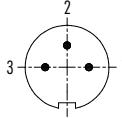

4 pol  
4 contacts

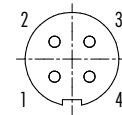
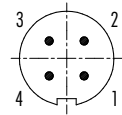

5 pol  
5 contacts

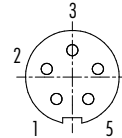
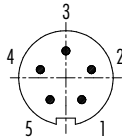

7 pol  
7 contacts

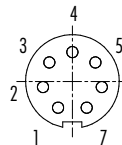
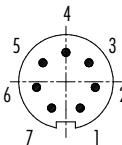

8 pol  
8 contacts

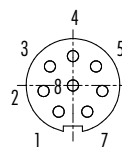
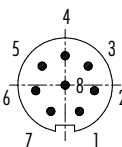

Montageausschnitt  
Panel cut out

