

Kabelstecker
Male cable connector

Kabelstecker
Male cable connector

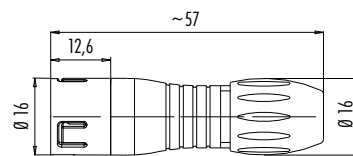
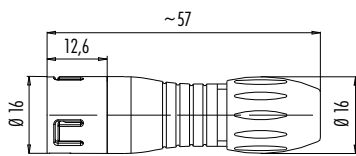

Polzahl Contacts	Kabeldurchlass Cable outlet	Bestell-Nr. Ordering-No.
3	2,5–4 mm	99 9105 03 03
5	2,5–4 mm	99 9113 03 05
8	2,5–4 mm	99 9125 03 08
12	2,5–4mm	—

Polzahl Contacts	Kabeldurchlass Cable outlet	Bestell-Nr. Ordering-No.
3	4–6 mm	99 9105 00 03
5	4–6 mm	99 9113 00 05
8	4–6 mm	99 9125 00 08
12	4–6 mm	99 9133 00 12

Polzahl	3	5	8	12	Number of contacts
Steckverbinder Verriegelung	schnapp/snap-in				Connector locking system
Anschlussart	löten/solder				Termination
Anschlussquerschnitt	max. 0,75 mm ² (max. AWG 18)		max. 0,25 mm ² (max. AWG 24)		Wire gauge
Kabeldurchlass	2,5–4 mm, 4–6 mm				Cable outlet
Schutzart	IP67				Degree of protection
Mechanische Lebensdauer	> 500 Steckzyklen/> 500 mating cycles				Mechanical operation
Obere Grenztemperatur	+ 85 °C				Upper temperature
Untere Grenztemperatur	– 25 °C				Lower temperature
Bemessungsspannung	250 V	125 V	125 V	60 V	Rated voltage
Bemessungs-Stoßspannung	2500 V	1500 V	1500 V	800 V	Rated impulse voltage
Verschmutzungsgrad	2				Pollution degree
Überspannungskategorie	II				Overvoltage categorie
Isolierstoffgruppe	II				Material group
Bemessungsstrom (40 °C)	7 A	5 A	2 A		Rated current (40 °C)
Material Kontakt	CuZn (Messing/brass)				Material of contact
Kontaktoberfläche	Au (Gold/gold)				Contact plating
Material Kontaktkörper	PA				Material of contact body
Material Gehäuse	PA				Material of housing
Material Verriegelung	—				Material of locking

Kabelstecker
Male cable connector

Kabelstecker, rot, blau, grün
Male cable connector, red, blue, green

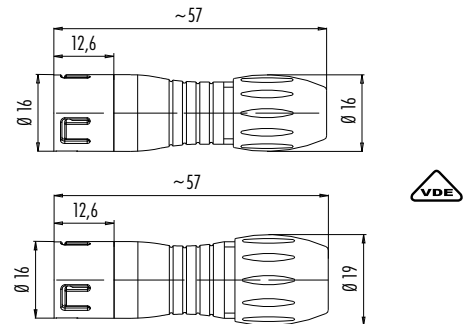
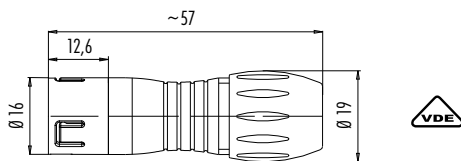

Polzahl Contacts	Kabeldurchlass Cable outlet	Bestell-Nr. Ordering-No.
3	6–8 mm	99 9105 02 03
5	6–8 mm	99 9113 02 05
8	6–8 mm	99 9125 02 08
12	6–8 mm	99 9133 02 12

Polzahl Contacts	Kabeldurchlass Cable outlet	Rot Red	Blau Blue	Grün Green
3	4–6 mm	99 9105 50 03	99 9105 60 03	99 9105 70 03
5	4–6 mm	99 9113 50 05	99 9113 60 05	99 9113 70 05
8	4–6 mm	99 9125 50 08	99 9125 60 08	99 9125 70 08
12	6–8 mm	99 9133 52 12	99 9133 62 12	99 9133 72 12

Polzahl	3	5	8	12	Number of contacts
Steckverbinder Verriegelung	schnapp/snap-in				Connector locking system
Anschlussart	löten/solder				Termination
Anschlussquerschnitt	max. 0,75 mm ² (max. AWG 18)		max. 0,25 mm ² (max. AWG 24)		Wire gauge
Kabeldurchlass	4–6 mm, 6–8 mm				Cable outlet
Schutzart	IP67				Degree of protection
Mechanische Lebensdauer	> 500 Steckzyklen/> 500 mating cycles				Mechanical operation
Obere Grenztemperatur	+ 85 °C				Upper temperature
Untere Grenztemperatur	– 25 °C				Lower temperature
Bemessungsspannung	250 V	125 V	125 V	60 V	Rated voltage
Bemessungs-Stoßspannung	2500 V	1500 V	1500 V	800 V	Rated impulse voltage
Verschmutzungsgrad	2				Pollution degree
Überspannungskategorie	II				Overvoltage categorie
Isolierstoffgruppe	II				Material group
Bemessungsstrom (40°C)	7 A	5 A	2 A		Rated current (40 °C)
Material Kontakt	CuZn (Messing/brass)				Material of contact
Kontaktoberfläche	Au (Gold/gold)				Contact plating
Material Kontaktkörper	PA				Material of contact body
Material Gehäuse	PA				Material of housing
Material Verriegelung	—				Material of locking

Kabeldose
Female cable connector

Kabeldose
Female cable connector

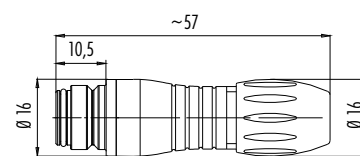
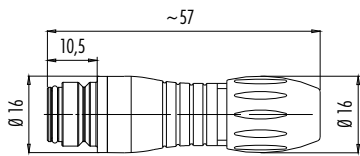

Polzahl Contacts	Kabeldurchlass Cable outlet	Bestell-Nr. Ordering-No.
3	2,5–4 mm	99 9106 03 03
5	2,5–4 mm	99 9114 03 05
8	2,5–4 mm	99 9126 03 08
12	2,5–4mm	—

Polzahl Contacts	Kabeldurchlass Cable outlet	Bestell-Nr. Ordering-No.
3	4–6 mm	99 9106 00 03
5	4–6 mm	99 9114 00 05
8	4–6 mm	99 9126 00 08
12	4–6 mm	99 9134 00 12

Polzahl	3	5	8	12	Number of contacts
Steckverbinder Verriegelung	schnapp/snap-in				Connector locking system
Anschlussart	löten/solder				Termination
Anschlussquerschnitt	max. 0,75 mm ² (max. AWG 18)		max. 0,25 mm ² (max. AWG 24)		Wire gauge
Kabeldurchlass	2,5–4 mm, 4–6 mm				Cable outlet
Schutzart	IP67				Degree of protection
Mechanische Lebensdauer	> 500 Steckzyklen/> 500 mating cycles				Mechanical operation
Obere Grenztemperatur	+ 85 °C				Upper temperature
Untere Grenztemperatur	– 25 °C				Lower temperature
Bemessungsspannung	250 V	125 V	125 V	60 V	Rated voltage
Bemessungs-Stoßspannung	2500 V	1500 V	1500 V	800 V	Rated impulse voltage
Verschmutzungsgrad	2				Pollution degree
Überspannungskategorie	II				Overvoltage categorie
Isolierstoffgruppe	II				Material group
Bemessungsstrom (40 °C)	7 A	5 A	2 A		Rated current (40 °C)
Material Kontakt	CuSn (Bronze/bronze)				Material of contact
Kontaktoberfläche	Au (Gold/gold)				Contact plating
Material Kontaktkörper	PA				Material of contact body
Material Gehäuse	PA				Material of housing
Material Verriegelung	—				Material of locking

Kabeldose
Female cable connector

Kabeldose, rot, blau, grün
Female cable connector, red, blue, green

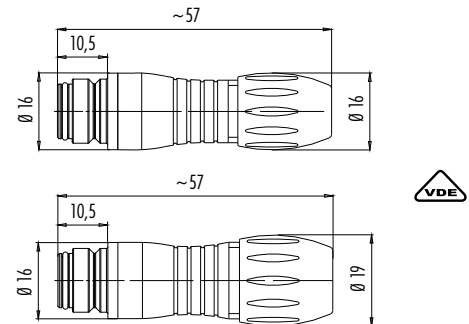
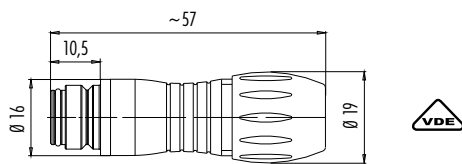

Polzahl Contacts	Kabeldurchlass Cable outlet	Bestell-Nr. Ordering-No.
3	6–8 mm	99 9106 02 03
5	6–8 mm	99 9114 02 05
8	6–8 mm	99 9126 02 08
12	6–8 mm	99 9134 02 12

Polzahl Contacts	Kabeldurchlass Cable outlet	Rot Red	Blau Blue	Grün Green
3	4–6 mm	99 9106 50 03	99 9106 60 03	99 9106 70 03
5	4–6 mm	99 9114 50 05	99 9114 60 05	99 9114 70 05
8	4–6 mm	99 9126 50 08	99 9126 60 08	99 9126 70 08
12	6–8 mm	99 9134 52 12	99 9134 62 12	99 9134 72 12

Polzahl	3	5	8	12	Number of contacts
Steckverbinder Verriegelung	schnapp/snap-in				Connector locking system
Anschlussart	löten/solder				Termination
Anschlussquerschnitt	max. 0,75 mm ² (max. AWG 18)		max. 0,25 mm ² (max. AWG 24)		Wire gauge
Kabeldurchlass	4–6 mm, 6–8 mm				Cable outlet
Schutzart	IP67				Degree of protection
Mechanische Lebensdauer	> 500 Steckzyklen/> 500 mating cycles				Mechanical operation
Obere Grenztemperatur	+ 85 °C				Upper temperature
Untere Grenztemperatur	– 25 °C				Lower temperature
Bemessungsspannung	250 V	125 V	125 V	60 V	Rated voltage
Bemessungs-Stoßspannung	2500 V	1500 V	1500 V	800 V	Rated impulse voltage
Verschmutzungsgrad	2				Pollution degree
Überspannungskategorie	II				Overvoltage categorie
Isolierstoffgruppe	II				Material group
Bemessungsstrom (40°C)	7 A	5 A	2 A		Rated current (40 °C)
Material Kontakt	CuSn (Bronze/bronze)				Material of contact
Kontaktoberfläche	Au (Gold/gold)				Contact plating
Material Kontaktkörper	PA				Material of contact body
Material Gehäuse	PA				Material of housing
Material Verriegelung	—				Material of locking

Flanschstecker
Male panel mount connector

Flanschstecker, rot
Male panel mount connector, red

Flanschstecker, blau
Male panel mount connector, blue

Flanschstecker, grün
Male panel mount connector, green

Flanschstecker, tauchlöten
Male panel mount connector,
dip solder



Bohrbilder siehe Seite 13
Drilling schemes see page 13

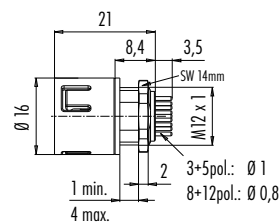
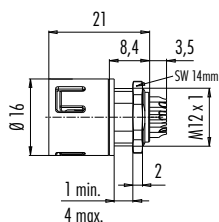

Polzahl Contacts	Bestell-Nr. Ordering-No.	Polzahl Contacts	Bestell-Nr. Ordering-No.	Polzahl Contacts	Bestell-Nr. Ordering-No.	Polzahl Contacts	Bestell-Nr. Ordering-No.	Polzahl Contacts	Bestell-Nr. Ordering-No.
3	99 9107 00 03	3	99 9107 50 03	3	99 9107 60 03	3	99 9107 70 03	3	99 9107 090 03
5	99 9115 00 05	5	99 9115 50 05	5	99 9115 60 05	5	99 9115 70 05	5	99 9115 090 05
8	99 9127 00 08	8	99 9127 50 08	8	99 9127 60 08	8	99 9127 70 08	8	99 9127 090 08
12	99 9135 00 12	12	99 9135 50 12	12	99 9135 60 12	12	99 9135 70 12	12	99 9135 090 12

Polzahl	3	5	8	12	Number of contacts
Steckverbinder Verriegelung	schnapp/snap-in				Connector locking system
Anschlussart	löten/tauchlöten/solder/dip solder				Termination
Anschlussquerschnitt	max. 0,75 mm ² (max. AWG 18)		max. 0,25 mm ² (max. AWG 24)		Wire gauge
Kabeldurchlass	—				Cable outlet
Schutzart	IP67				Degree of protection
Mechanische Lebensdauer	> 500 Steckzyklen/> 500 mating cycles				Mechanical operation
Obere Grenztemperatur	+ 85 °C				Upper temperature
Untere Grenztemperatur	- 25 °C				Lower temperature
Bemessungsspannung	250 V	125 V	125 V	60 V	Rated voltage
Bemessungs-Stoßspannung	2500 V	1500 V	1500 V	800 V	Rated impulse voltage
Verschmutzungsgrad	2				Pollution degree
Überspannungskategorie	II				Overvoltage categorie
Isolierstoffgruppe	II				Material group
Bemessungsstrom (40°C)	7 A	5 A	2 A		Rated current (40 °C)
Material Kontakt	CuZn (Messing/brass)				Material of contact
Kontaktoberfläche	Au (Gold/gold)				Contact plating
Material Kontaktkörper	PA				Material of contact body
Material Gehäuse	PA				Material of housing
Material Verriegelung	—				Material of locking

Flanschdose
Female panel mount connector

Flanschdose, rot
Female panel mount connector, red

Flanschdose, blau
Female panel mount connector, blue

Flanschdose, grün
Female panel mount connector, green

Flanschdose, tauchlöten
Female panel mount connector, dip solder



Bohrbilder siehe Seite 13
Drilling schemes see page 13

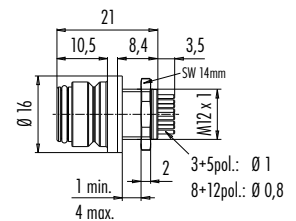
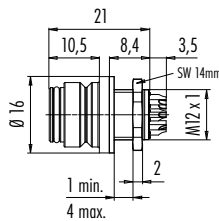

Polzahl Contacts	Bestell-Nr. Ordering-No.	Polzahl Contacts	Bestell-Nr. Ordering-No.	Polzahl Contacts	Bestell-Nr. Ordering-No.	Polzahl Contacts	Bestell-Nr. Ordering-No.	Polzahl Contacts	Bestell-Nr. Ordering-No.
3	99 9108 00 03	3	99 9108 50 03	3	99 9108 60 03	3	99 9108 70 03	3	99 9108 090 03
5	99 9116 00 05	5	99 9116 50 05	5	99 9116 60 05	5	99 9116 70 05	5	99 9116 090 05
8	99 9128 00 08	8	99 9128 50 08	8	99 9128 60 08	8	99 9128 70 08	8	99 9128 090 08
12	99 9136 00 12	12	99 9136 50 12	12	99 9136 60 12	12	99 9136 70 12	12	99 9136 090 12

Polzahl	3	5	8	12	Number of contacts
Steckverbinder Verriegelung	schnapp/snap-in				Connector locking system
Anschlussart	löten/tauchlöten/solder/dip solder				Termination
Anschlussquerschnitt	max. 0,75 mm ² (max. AWG 18)		max. 0,25 mm ² (max. AWG 24)		Wire gauge
Kabeldurchlass	—				Cable outlet
Schutzart	IP67				Degree of protection
Mechanische Lebensdauer	> 500 Steckzyklen/> 500 mating cycles				Mechanical operation
Obere Grenztemperatur	+ 85 °C				Upper temperature
Untere Grenztemperatur	- 25 °C				Lower temperature
Bemessungsspannung	250 V	125 V	125 V	60 V	Rated voltage
Bemessungs-Stoßspannung	2500 V	1500 V	1500 V	800 V	Rated impulse voltage
Verschmutzungsgrad	2				Pollution degree
Überspannungskategorie	II				Overvoltage categorie
Isolierstoffgruppe	II				Material group
Bemessungsstrom (40°C)	7 A	5 A	2 A		Rated current (40 °C)
Material Kontakt	CuSn (Bronze/bronze)				Material of contact
Kontaktoberfläche	Au (Gold/gold)				Contact plating
Material Kontaktkörper	PA				Material of contact body
Material Gehäuse	PA				Material of housing
Material Verriegelung	—				Material of locking

Zweifachverteiler, Stecker – 2 Dosen
Twin distributor, male connector – 2 female connectors



Bohrbilder siehe Seite 13
Drilling schemes see page 13

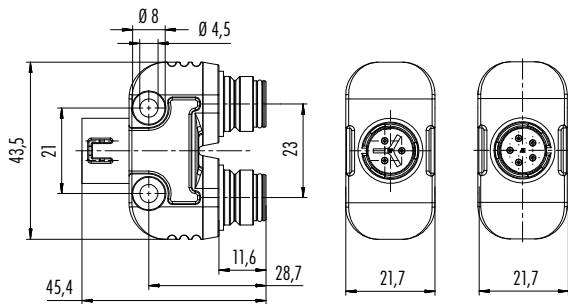

Polzahl Contacts	Bestell-Nr. Ordering-No.	Schaltungen Wirings
3	79 9179 000 03	
5	79 9180 000 05	

Polzahl	3	5	Number of contacts
Steckverbinder Verriegelung	schnapp/snap-in		Connector locking system
Anschlussart	—		Termination
Anschlussquerschnitt	—		Wire gauge
Kabeldurchlass	—		Cable outlet
Schutzart	IP67		Degree of protection
Mechanische Lebensdauer	> 500 Steckzyklen/> 500 mating cycles		Mechanical operation
Obere Grenztemperatur	+ 85 °C		Upper temperature
Untere Grenztemperatur	- 40 °C		Lower temperature
Bemessungsspannung	250 V	125 V	Rated voltage
Bemessungs-Stoßspannung	2500 V	1500 V	Rated impulse voltage
Verschmutzungsgrad	2		Pollution degree
Überspannungskategorie	II		Overvoltage categorie
Isolierstoffgruppe	II		Material group
Bemessungsstrom (40°C)	7 A	5 A	Rated current (40 °C)
Material Kontakt	Stift/pin CuZn (Messing/brass), Buchse/socket CuSn (Bronze/bronze)		Material of contact
Kontaktoberfläche	Au (Gold/gold)		Contact plating
Material Kontaktkörper	PA		Material of contact body
Material Gehäuse	PA		Material of housing
Material Verriegelung	—		Material of locking

Kabelstecker umspritzt
Male cable connector moulded



Kabeldose umspritzt
Female cable connector moulded

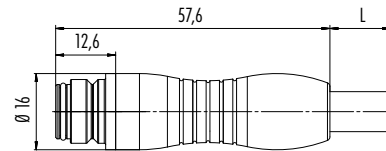
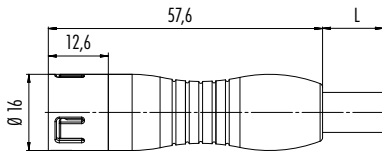

Polzahl Contacts	Kabellänge Cable length	Bestell-Nr. Ordering-No.
3	2 m	77 6405 0000 50003-0200
		79 9149 120 03
5	2 m	77 6405 0000 50005-0200
		79 9157 120 05
8	2 m	77 6405 0000 50008-0200
12	2 m	77 6405 0000 50012-0200

Polzahl Contacts	Kabellänge Cable length	Bestell-Nr. Ordering-No.
3	2 m	77 6406 0000 50003-0200
		79 9150 120 03
5	2 m	77 6406 0000 50005-0200
		79 9158 120 05
8	2 m	77 6406 0000 50008-0200
12	2 m	77 6406 0000 50012-0200

Technische Daten Kabel	3		5		8	12	Specifications of cable
Querschnitt mm ² ¹⁾	3 x 0,75 mm ²		5 x 0,75 mm ²		8 x 0,25 mm ²	12 x 0,25 mm ²	Wire gauge mm ² ¹⁾
Material Mantel	PUR						Material jacket
Isolation Litze	PVC	EPDM	PP	EPDM	PP	PP	Insulation wire
Litzenaufbau (mm)	24 x 0,2 mm	22 x 0,2 mm	24 x 0,2 mm	22 x 0,2 mm	32 x 0,1 mm	14 x 0,15 mm	Design of wire (mm)
Kabelmantel Ø (mm)	6,9 ±0,2	6,8 ±0,3	6,3 ±0,2	8,2 ±0,3	6 ±0,2	6,5 ±0,2	Cable jacket Ø (mm)
Leiterwiderstand	26 Ω/km	26,7 Ω/km	26 Ω/km	26,7 Ω/km	79,0 Ω/km		Resistance of wire
Temp.-Bereich (Kabel bew.)	- 5°C /+ 70°C	- 30°C /+ 90°C	- 25°C /+ 80°C	- 30°C /+ 90°C	- 25°C /+ 80°C		Temp. range (cable in move)
Temp.-Bereich (Kabel fest)	- 40°C /+ 80°C	- 40°C /+ 90°C	- 40°C /+ 80°C	- 40°C /+ 90°C	- 50°C /+ 80°C		Temp. range (cable fixed)
Biegeradius (Kabel bew.)	69 mm	—	63 mm	—	60 mm	65 mm	Bending radius (cable in move)
Biegeradius (Kabel fest)	34,5 mm	81,6 mm	31,5 mm	102,5 mm	30 mm	32,5 mm	Bending radius (cable fixed)
Zulassung	UL	VDE	UL	VDE	UL		Approval

Polzahl	3		5		8	12	Number of contacts
Steckverbinder Verriegelung	schnapp/snap-in						Connector locking system
Anschlussart	am Kabel angespritzt/moulded						Termination
Anschlussquerschnitt	max. 0,75 mm ² (max. AWG 18)			max. 0,25 mm ² (max. AWG 24)			Wire gauge
Kabeldurchlass	—						Cable outlet
Schutzart	IP67						Degree of protection
Mechanische Lebensdauer	> 500 Steckzyklen/> 500 mating cycles						Mechanical operation
Obere Grenztemperatur	+ 85 °C						Upper temperature
Untere Grenztemperatur	- 25 °C						Lower temperature
Bemessungsspannung	250 V	125 V	125 V	125 V	60 V	Rated voltage	
Bemessungs-Stoßspannung	2500 V	1500 V	1500 V	1500 V	800 V	Rated impulse voltage	
Verschmutzungsgrad	2						Pollution degree
Überspannungskategorie	II						Overvoltage categorie
Isolierstoffgruppe	II						Material group
Bemessungsstrom (40°C)	7 A	5 A	5 A	5 A	2 A	Rated current (40 °C)	
Material Kontakt	Stift/pin CuZn (Messing/brass), Buchse/socket CuSn (Bronze/bronze)						Material of contact
Kontaktoberfläche	Au (Gold/gold)						Contact plating
Material Kontaktkörper	PA						Material of contact body
Material Gehäuse	PA						Material of housing
Material Verriegelung	—						Material of locking

¹⁾ Vergleichbare AWG Leiter siehe technische Informationen. / ¹⁾ Comparable AWG conductors see technical information.

Montageanleitung
Assembly instruction

1. Kupplungshülse, Dichtring, Klemmkorb und Druckschraube auf Kabel auffädeln.
2. Kabel abmanteln auf L = 15 mm.
3. Litzen abisolieren und anschließen.
4. Kupplungshülse auf montierten Kontakteinsatz schrauben.
5. Dichtring und Klemmkorb in Kupplungshülse schieben und mit Druckschraube festdrehen.

1. Bead sleeve, seal, pinch ring and pressing screw to cable.
2. Dismantle cable to 15 mm length.
3. Strip and connect single wires.
4. Screw the sleeve onto the assembled contact insert.
5. Push seal and pinch ring into the sleeve and tighten it with the pressing screw.

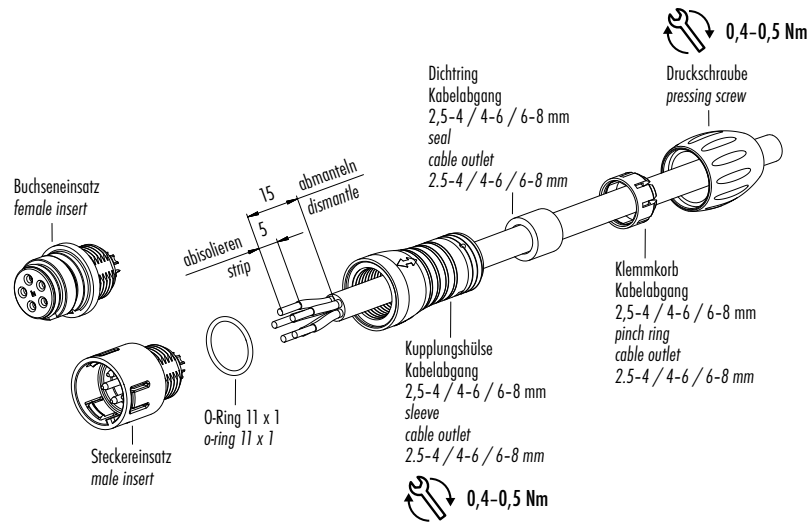

Einzelteildarstellung
Component part drawing

Flanschsteckverbinder, löten
Panel mount connectors, solder

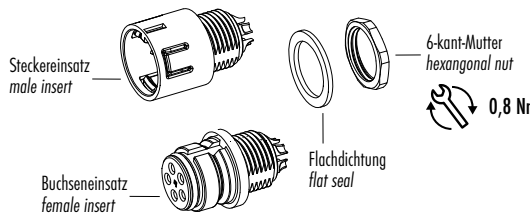

Flanschsteckverbinder, tauchlöten
Panel mount connectors, dip solder

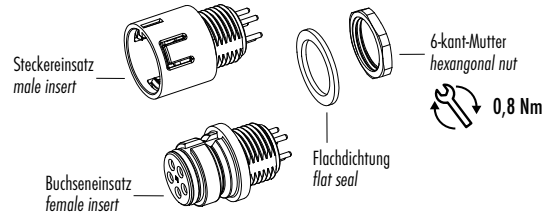

Montage Adapter
Assembly of adapter

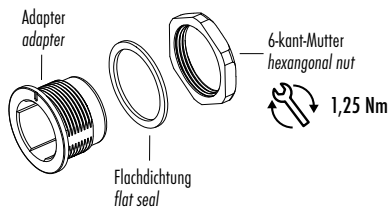

Montage Adapter, von vorn verschraubbar
Assembly of adapter, front fastened

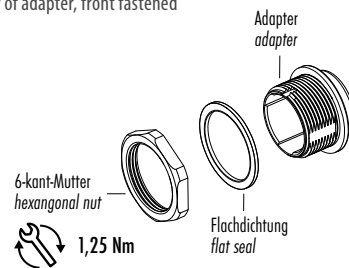

Adapter
Adapter

Die Markierung des Adapters muss mit der Kodiumse des Einsatzes übereinstimmen
The marking of the adapter must conform with the coding nut of the insert

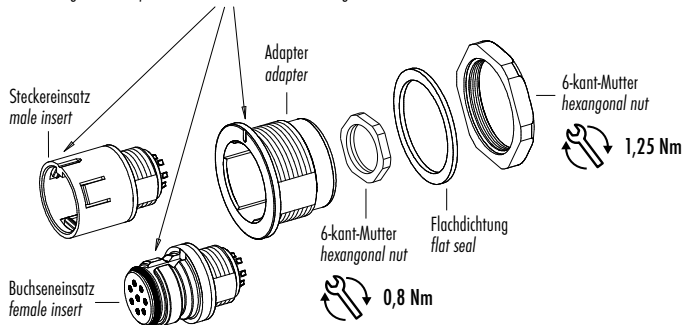

Adapter, von vorn verschraubbar
Adapter, front fastened

Die Markierung des Adapters muss mit der Kodiumse des Einsatzes übereinstimmen
The marking of the adapter must conform with the coding nut of the insert

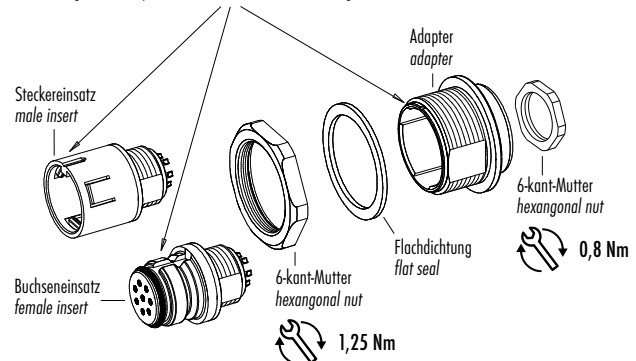

Einsätze müssen separat bestellt werden
Inserts have to be ordered separately

Einsätze müssen separat bestellt werden
Inserts have to be ordered separately

Polbilder
Contact arrangements

Stifteinsatz (Steckseite)
Male insert (mating side)

Buchseinsatz (Steckseite)
Female insert (mating side)

3 pol
3 contacts

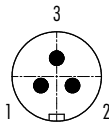

- 1 weiß/white
- 2 braun/brown
- 3 grün/green

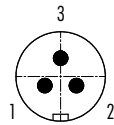

- 1 schwarz/black
- 2 braun/brown
- 3 grau/grey

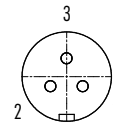

- 1 weiß/white
- 2 braun/brown
- 3 grün/green

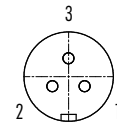

- 1 schwarz/black
- 2 braun/brown
- 3 grau/grey



5 pol
5 contacts

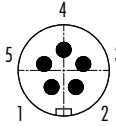

- 1 weiß/white
- 2 braun/brown
- 3 grün/green
- 4 gelb/yellow
- 5 grau/grey

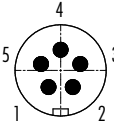

- 1 blau/blue
- 2 braun/brown
- 3 schwarz 1/black 1
- 4 grau/grey
- 5 schwarz 2/black 2

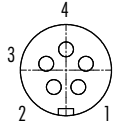

- 1 weiß/white
- 2 braun/brown
- 3 grün/green
- 4 gelb/yellow
- 5 grau/grey

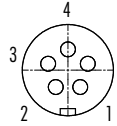

- 1 blau/blue
- 2 braun/brown
- 3 schwarz 1/black 1
- 4 grau/grey
- 5 schwarz 2/black 2



8 pol
8 contacts

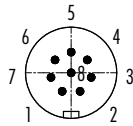

- 1 weiß/white
- 2 braun/brown
- 3 grün/green
- 4 gelb/yellow
- 5 grau/grey
- 6 rosa/pink
- 7 blau/blue
- 8 rot/red

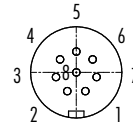

- 1 weiß/white
- 2 braun/brown
- 3 grün/green
- 4 gelb/yellow
- 5 grau/grey
- 6 rosa/pink
- 7 blau/blue
- 8 rot/red

12 pol
12 contacts

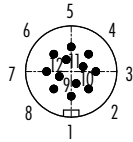

- 1 weiß/white
- 2 braun/brown
- 3 grün/green
- 4 gelb/yellow
- 5 grau/grey
- 6 rosa/pink
- 7 blau/blue
- 8 rot/red
- 9 schwarz/black
- 10 violett/purple
- 11 grau/rosa/grey/pink
- 12 rot/blau/red/blue

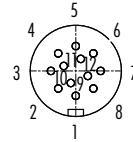

- 1 weiß/white
- 2 braun/brown
- 3 grün/green
- 4 gelb/yellow
- 5 grau/grey
- 6 rosa/pink
- 7 blau/blue
- 8 rot/red
- 9 schwarz/black
- 10 violett/purple
- 11 grau/rosa/grey/pink
- 12 rot/blau/red/blue

Bohrbilder Stifteinsatz (Leiterplatte), ungeschirmt
Drilling schemes male insert (PCB), unshielded

Bohrbilder Buchseinsatz (Leiterplatte), ungeschirmt
Drilling schemes female insert (PCB), unshielded

3 pol
3 contacts

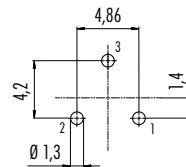
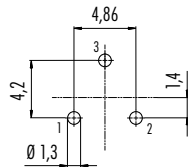

5 pol
5 contacts

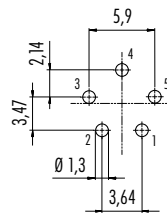
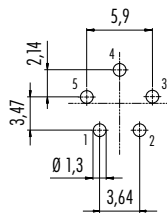

8 pol
8 contacts

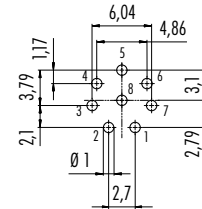
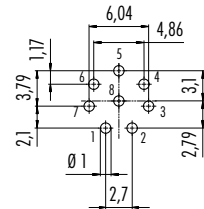

12 pol
12 contacts

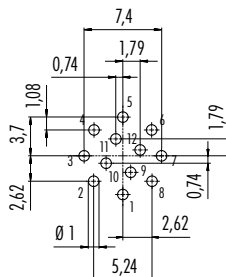
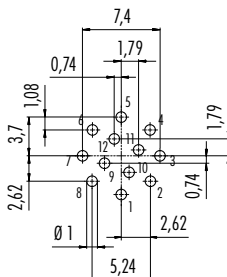

Montageausschnitt
Panel cut out

Flanschsteckverbinder
Socket connectors

Adapter
Adapter

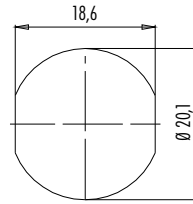
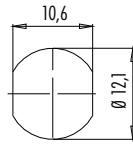

Zubehör Miniatur 720
Accessories Miniature

Snap-in IP67

Bezeichnung / Description

Maßzeichnung / Drawing

Bestell-Nr. / Ordering-No.

Schutzkappe für Kabelstecker
Protection cap for male cable connector

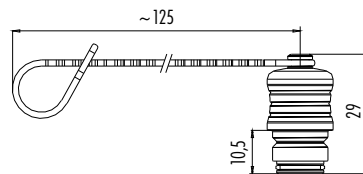

08 2587 000 000

Schutzkappe für Kabeldose
Protection cap for female cable connector

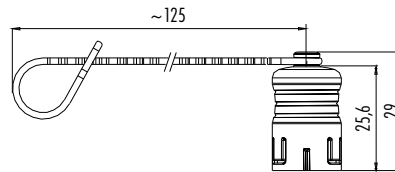

08 2586 000 000

Schutzkappe für Flanschstecker
Protection cap for male panel mount connector

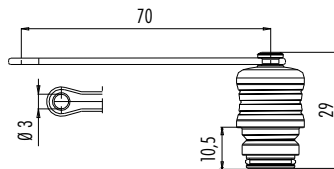

08 2559 000 000

Schutzkappe für Flanschstecker, M12
Protection cap for male panel mount connector, M12

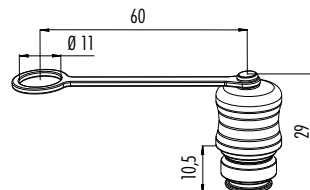

08 2680 000 000

Schutzkappe für Flanschstecker, M20
Protection cap for male panel mount connector, M20

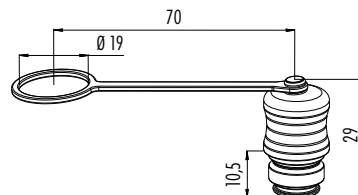

08 2674 000 000

Schutzkappe für Flanschdose
Protection cap for female panel mount connector

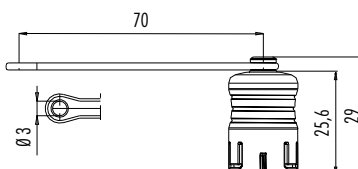

08 2567 000 000

Bezeichnung / Description	Maßzeichnung / Drawing	Bestell-Nr. / Ordering-No.
---------------------------	------------------------	----------------------------

Schutzkappe für Flanschdose, M12
Protection cap for female panel mount connector, M12

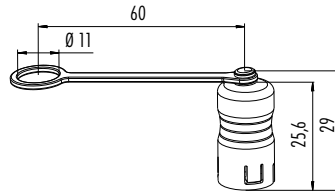

08 2681 000 000

Schutzkappe für Flanschdose, M20
Protection cap for female panel mount connector, M20

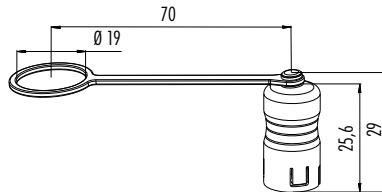

08 2675 000 000

Adapter für Flanschsteckverbinder
Adapter for panel mount connectors

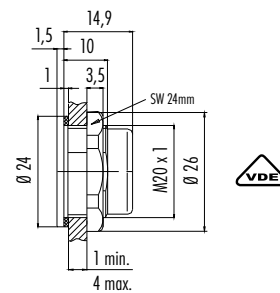

08 2433 000 001

Adapter für Flanschsteckverbinder, von vorn verschraubt
Adapter for panel mount connectors, front fastened

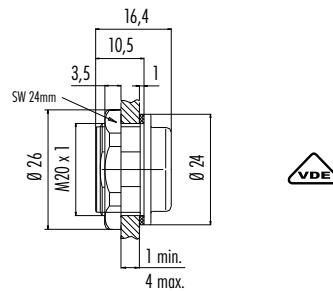

08 2434 000 001

Sicherungsclip
Safety clip

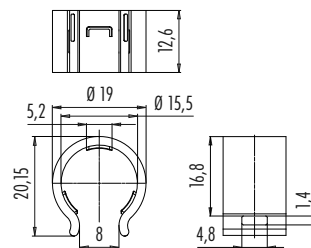

08 0216 000 000

Anwendungsbeispiel für Adapter
Example for use for adapter

Flanschstecker
Male panel mount connector



Flanschstecker mit Adapter
Male panel mount connector with adapter



Flanschdose
Female panel mount connector



Flanschdose mit Adapter, von vorn verschraubbar
Female panel mount connector with adapter, front fastened

